

Edition 400

31571700100 Waschtischunterbau

PRODUKT



ZEICHNUNG

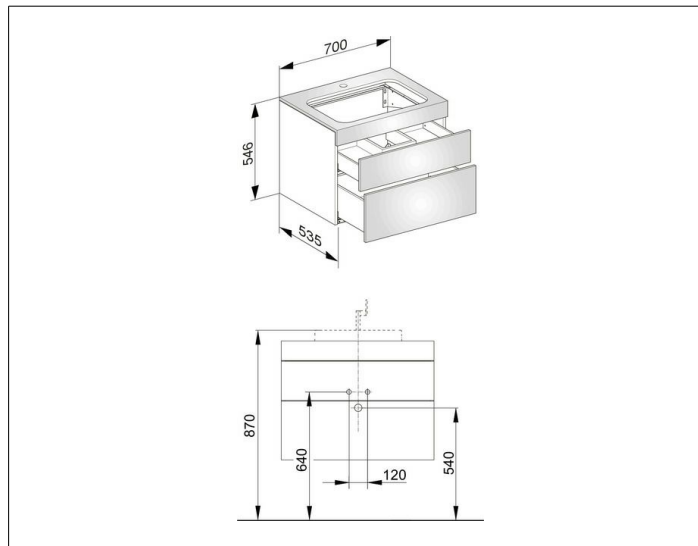

OBERFLÄCHE

weiß/Glas anthrazit klar

ABMESSUNG

700 x 546 x 535 mm