

Edition 11

31264570000 Waschtischunterbau

PRODUKT

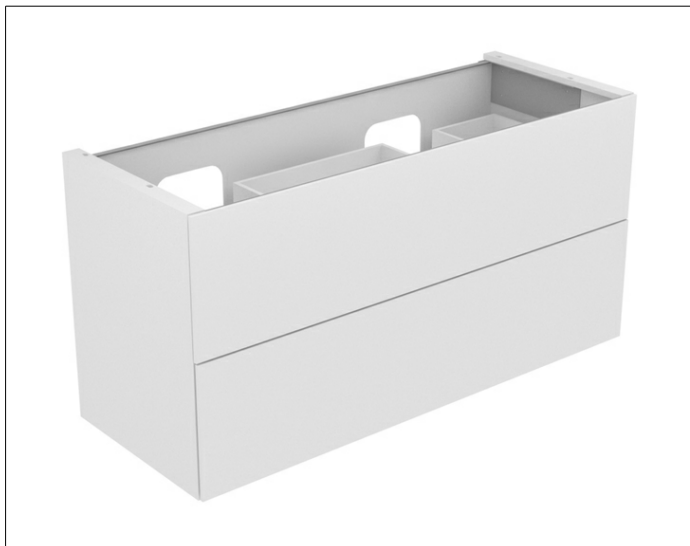

ZEICHNUNG

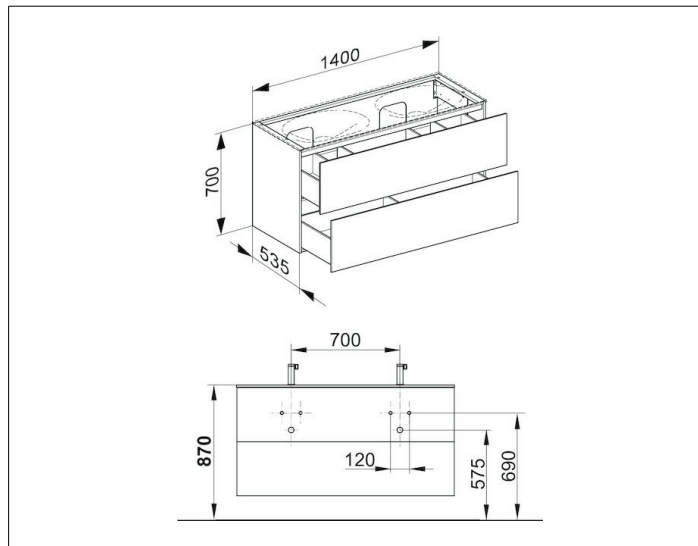

OBERFLÄCHE

schwarz/Glas schwarz

ABMESSUNG

1400 x 700 x 535 mm