

Edition 11

31256180000 Waschtischunterbau

PRODUKT



ZEICHNUNG

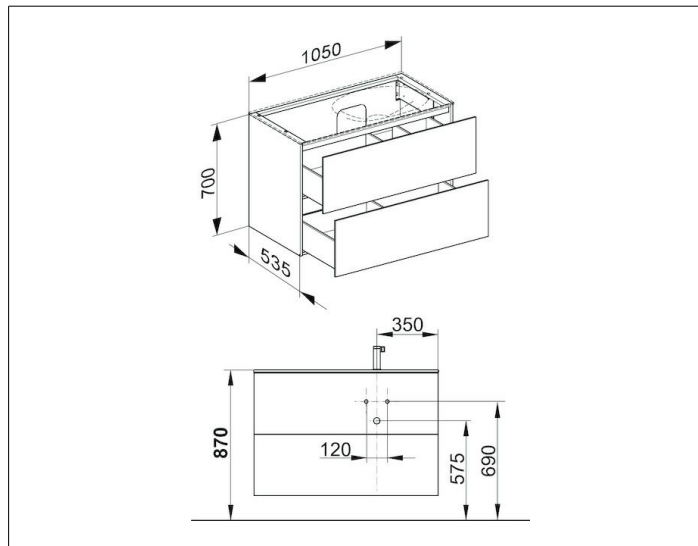

OBERFLÄCHE

cashmere/Glas cashmere

ABMESSUNG

1050 x 700 x 535 mm