

Edition 11

31268390000 Waschtischunterbau

PRODUKT



ZEICHNUNG

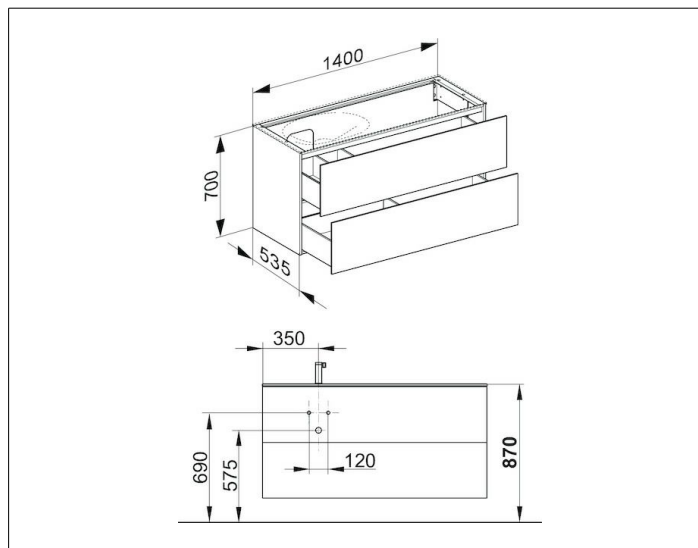

OBERFLÄCHE

anthrazit/anthrazit

ABMESSUNG

1400 x 700 x 535 mm