

Edition 11

31253570100 Waschtischunterbau

**PRODUKT**

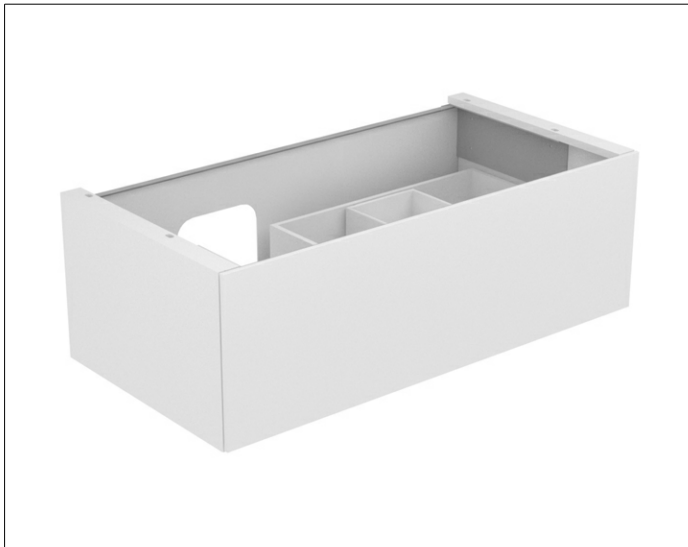

**ZEICHNUNG**

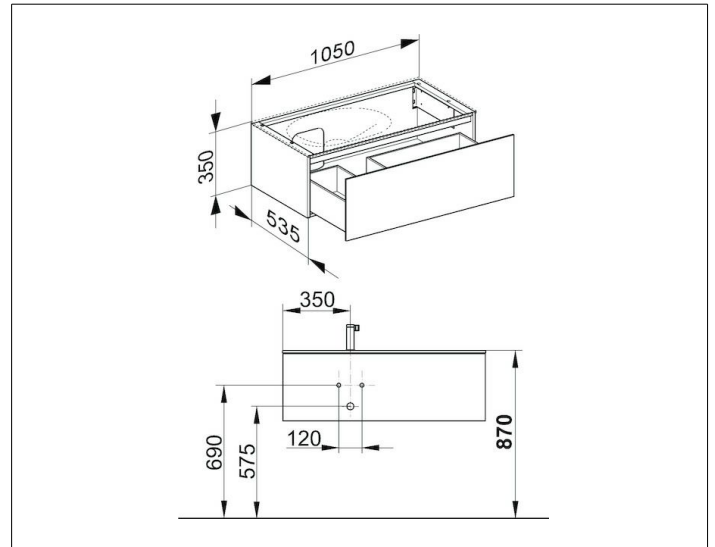

EEK: F , 7 kWh/1000h

**OBERFLÄCHE**

schwarz/Glas schwarz

**ABMESSUNG**

1050 x 350 x 535 mm