

Edition 11

31198380002 Waschtischunterbau

**PRODUKT**



**ZEICHNUNG**

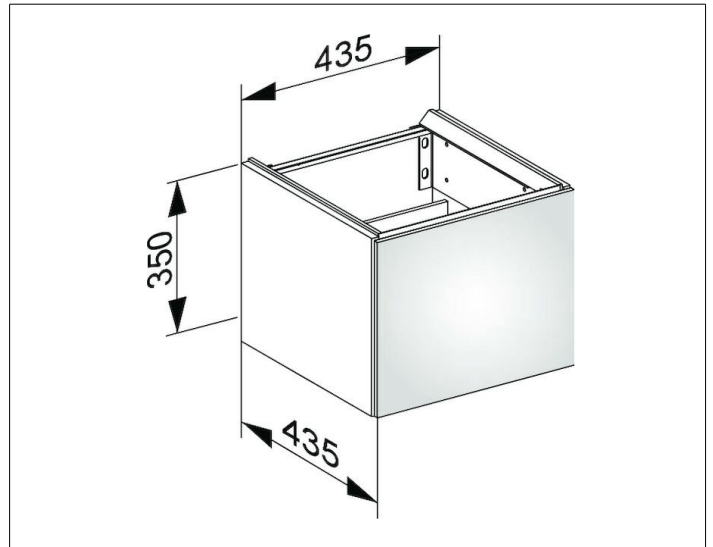

**OBERFLÄCHE**

weiß/weiß

**ABMESSUNG**

435 x 350 x 435 mm