

Edition 11

31267140100 Waschtischunterbau

PRODUKT

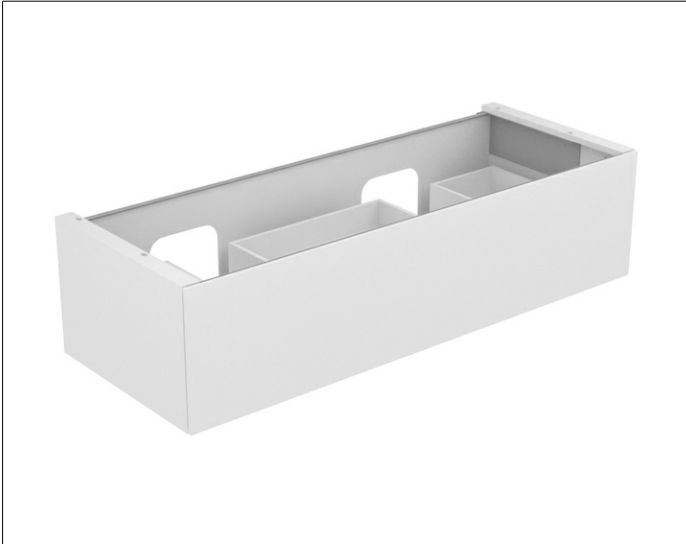

ZEICHNUNG

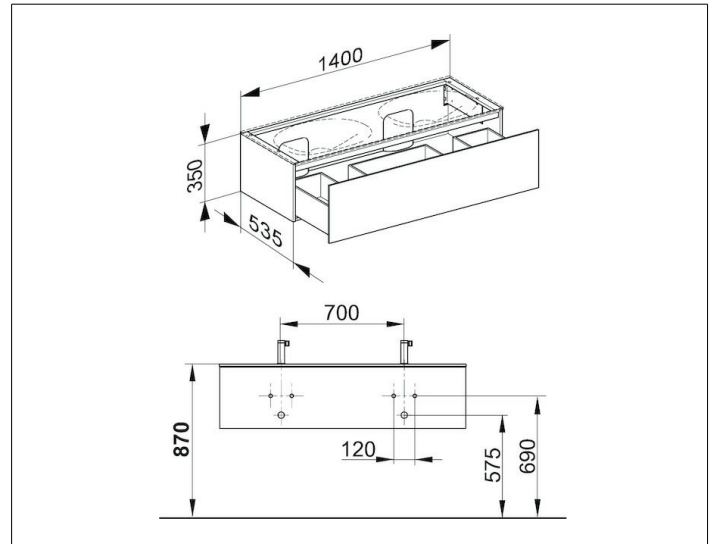

EEK: F , 10 kWh/1000h

OBERFLÄCHE

trüffel/Glas trüffel

ABMESSUNG

1400 x 350 x 535 mm