

Edition 11

31253390000 Waschtischunterbau

**PRODUKT**

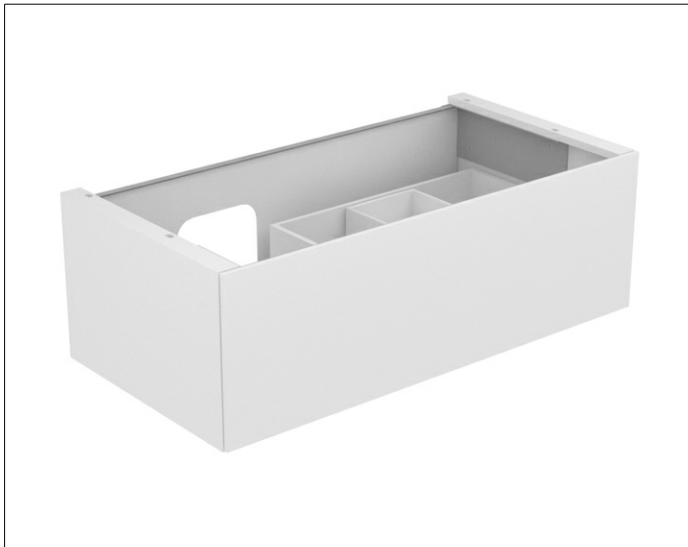

**ZEICHNUNG**

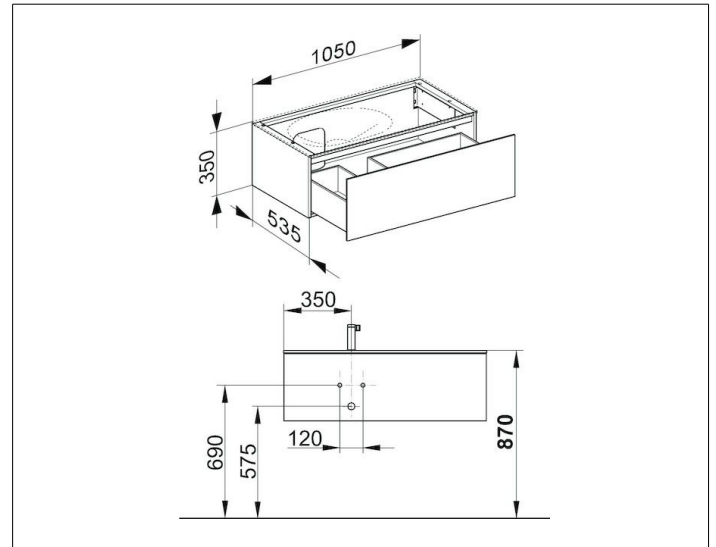

**OBERFLÄCHE**

anthrazit/anthrazit

**ABMESSUNG**

1050 x 350 x 535 mm