

Edition 11

31198570002 Waschtischunterbau

PRODUKT



ZEICHNUNG

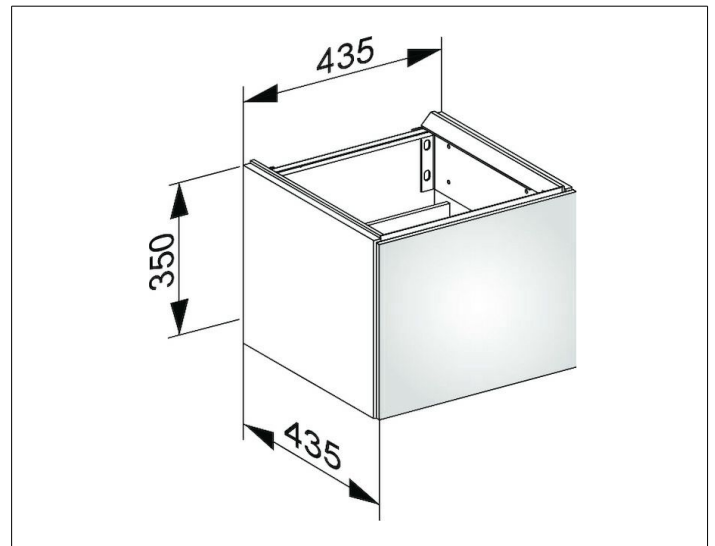

OBERFLÄCHE

schwarz/Glas schwarz

ABMESSUNG

435 x 350 x 435 mm