

Edition 400

31573870100 Waschtischunterbau

**PRODUKT**



**ZEICHNUNG**

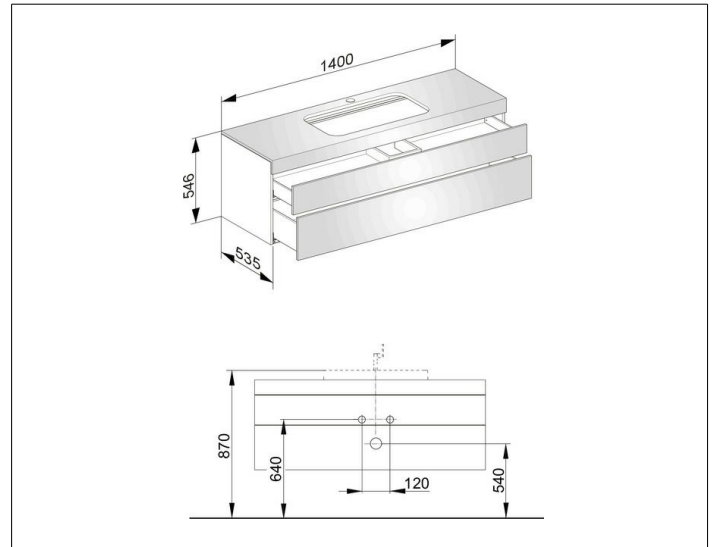

**OBERFLÄCHE**

Eiche cashmere/Eiche cashmere

**ABMESSUNG**

1400 x 546 x 535 mm