

X-Line

33122290002 Waschtischunterbau

PRODUKT

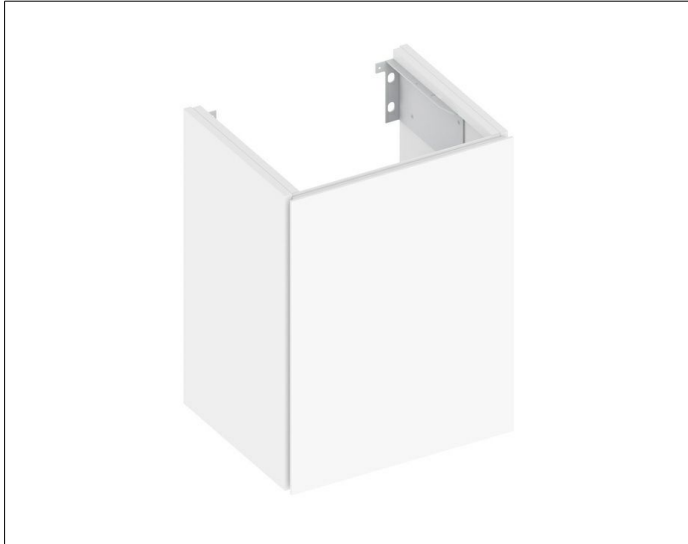

ZEICHNUNG

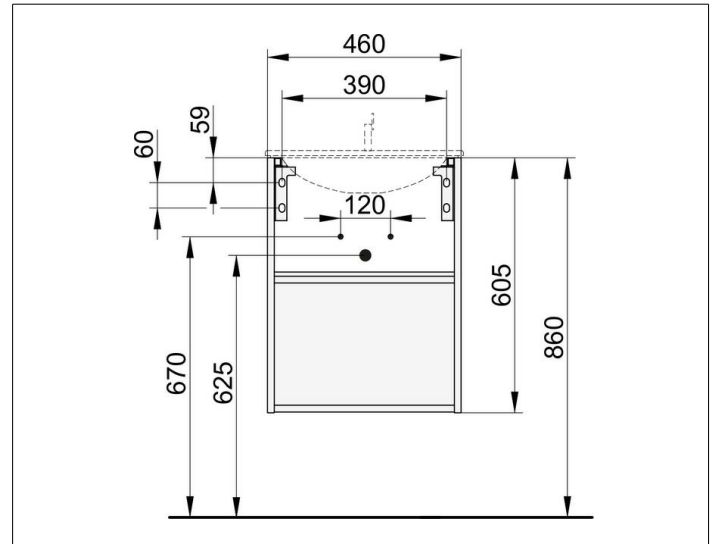

OBERFLÄCHE

inox/inox

ABMESSUNG

460 x 605 x 380 mm