

Edition 11

31326189000 Abdeckplatte

PRODUKT

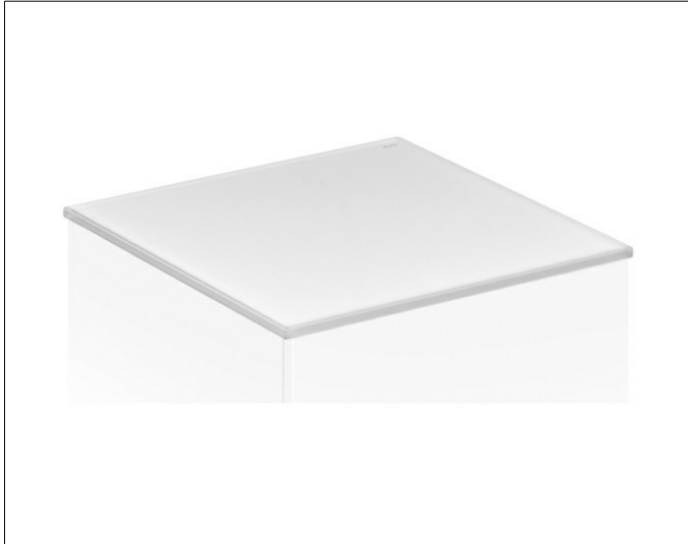

ZEICHNUNG

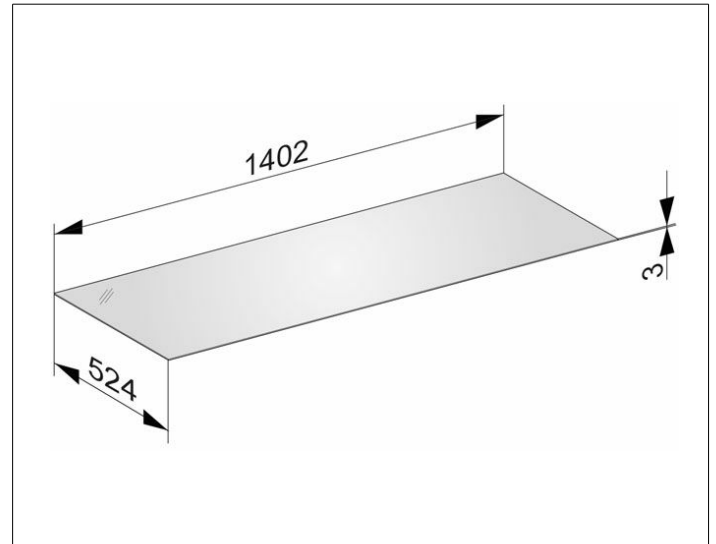

OBERFLÄCHE

cashmere/Glas cashmere

ABMESSUNG

1402 x 3 x 524 mm