

Edition 11

31310280000 Modul Unterbauschrank

PRODUKT

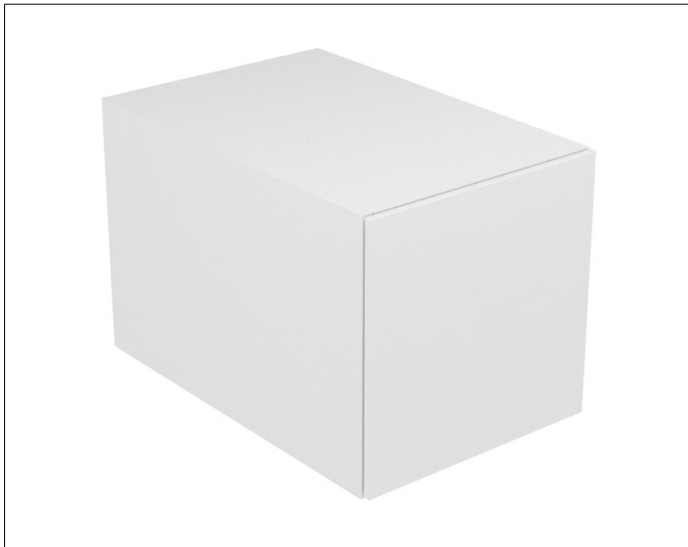

ZEICHNUNG

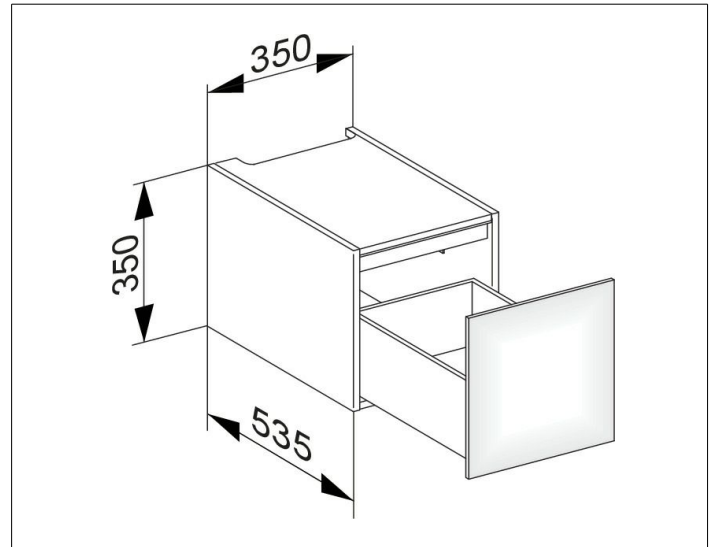

OBERFLÄCHE

cashmere/Glas cashmere satiniert

ABMESSUNG

350 x 350 x 535 mm