

Edition 11

31362390000 Waschtischunterbau

**PRODUKT**



**ZEICHNUNG**

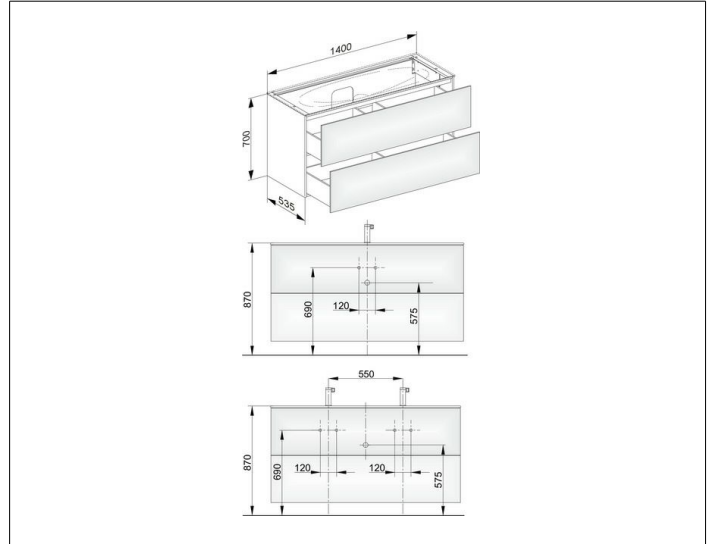

**OBERFLÄCHE**

anthrazit/anthrazit

**ABMESSUNG**

1400 x 700 x 535 mm