

DE Montageanleitung

NL Montagehandleiding

EN Mounting instruction

CS Návod k instalaci

ES Instrucciones de instalación

PL Instrukcja montażu

FR Instructions d'installation

RU Инструкция по монтажу

IT Istruzioni per l'installazione

59516 010101
59516 030101
59516 050101
59516 070101
59516 130101
59516 170101
59516 011101
59516 031101
59516 051101
59516 071101
59516 131101
59516 171101
59516 012101
59516 032101
59516 052101
59516 072101
59516 132101
59516 172101

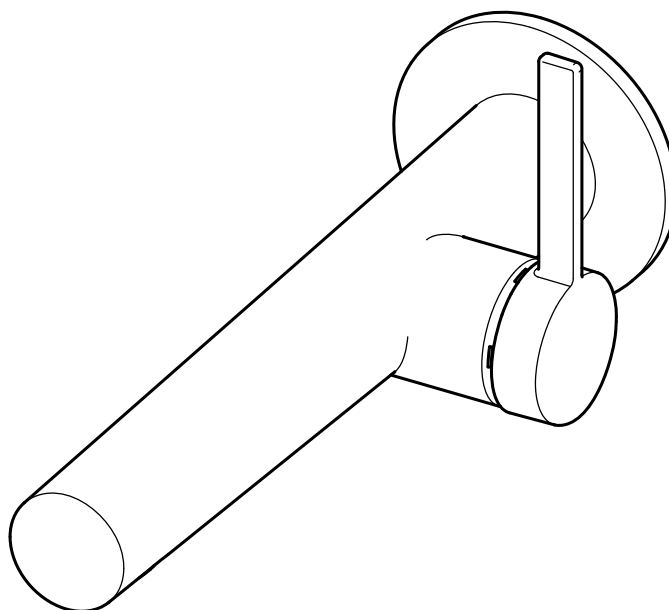

59516 010102
59516 030102
59516 050102
59516 070102
59516 130102
59516 170102
59516 011102
59516 031102
59516 051102
59516 071102
59516 131102
59516 171102
59516 012102
59516 032102
59516 052102
59516 072102
59516 132102
59516 172102

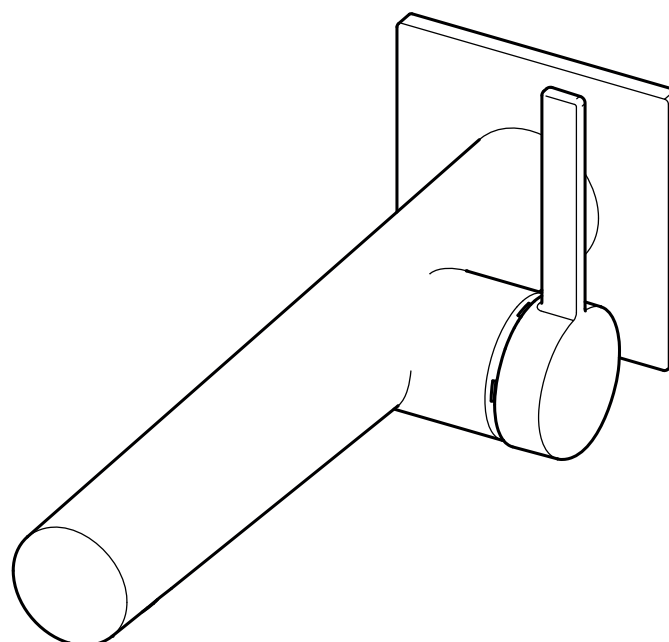

DE Einbaumaße

FR Cotes de montage

CS Montážní rozměry

EN Mounting dimensions

IT Ingombro

PL Wymiary montażowe

ES Dimensiones de montaje

NL Montageafmetingen

RU Монтажные размеры

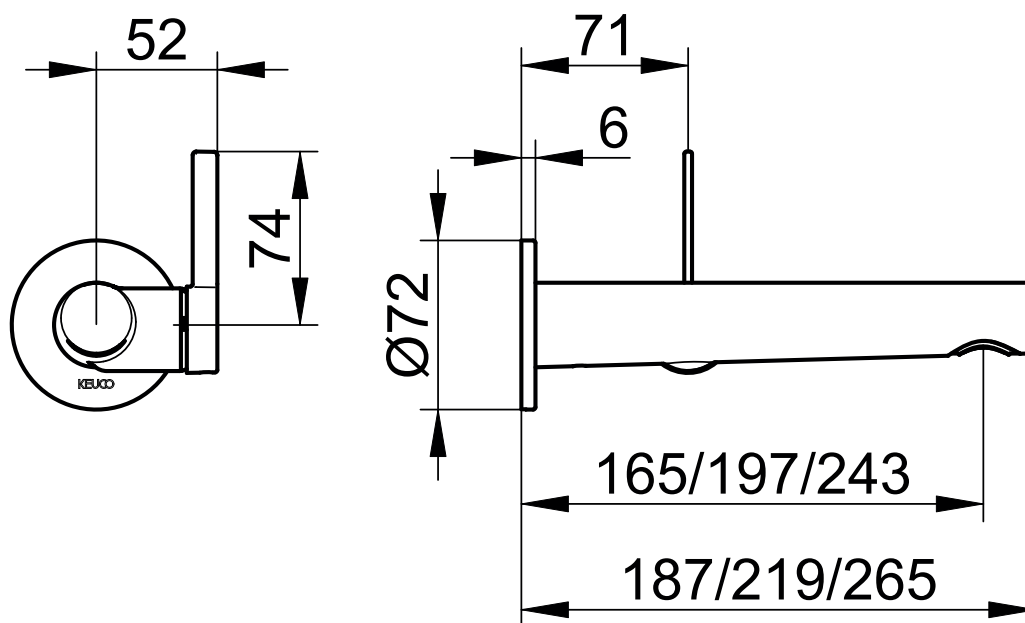

59516 XX0101 (187 mm)

59516 XX1101 (219 mm)

59516 XX2101 (265 mm)

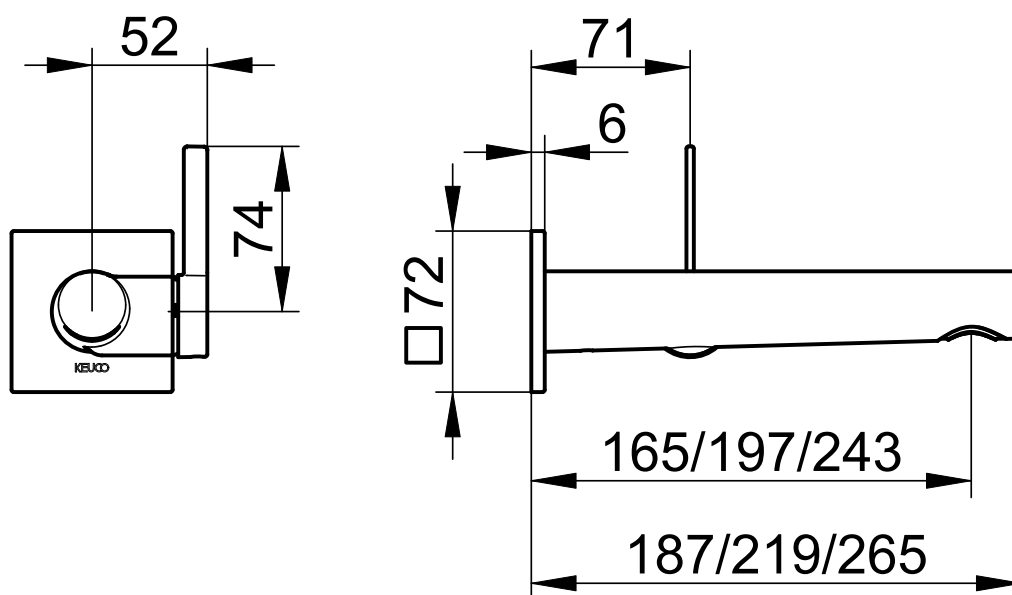











59516 XX0102 (187 mm)

59516 XX1102 (219 mm)

59516 XX2102 (265 mm)

 Diese Anleitung ist für den Installateur zur Montage sowie für den Nutzer zur Bedienung und Wartung des Produktes. Bitte nach der Installation an den Nutzer zur Verwahrung weitergeben.

Symbole und Bedeutung

-  **Achtung!** Warnung vor Personen- oder Sachschaden.
-  Hinweis, Tipp oder Verweis
-  Falsche Montage
-  Korrekte Montage/Funktionsprüfung
-  Montagedetail beachten
-  Kaltwasser
-  Warmwasser
-  Wasserfluss
-  Kein Wasserfluss
-  Optional/Zubehör

Verwendungszweck

 Einhebelmischer für die Verwendung in Badezimmer und WC.

Technische Daten

– Durchfluss bei 3 bar Fließdruck: ca. 7,6 l/min

Einbaumaße, siehe Seite 2.

Installation, siehe ab Bild 1 auf Seite 8.

 Trinkwasserleitungen vor und nach der Installation gründlich spülen (EN 806 und 1717 sowie DIN 1988 beachten).

Nur neutral vernetzendes Silikon verwenden.

Bedienung, siehe Bild 9 auf Seite 9

Wartung, siehe Bild 10 und 11 auf Seite 9

Montage in umgekehrter Reihenfolge.











– Anzugsmoment Kartuschenmutter: 12-13 Nm

Ersatzteile mit Bestellnummern, siehe Seite 11.

 Hinweise zur Gewährleistung und Pflege sind dem beiliegendem **Pflege- und Garantiepass** zu entnehmen.

 These instructions are for both the installer for installation and the user for operation and maintenance of the product. After installation, please hand them over to the user to keep.

Symbols and explanations

-  **Attention!** Warning against bodily injury or damage to property.
-  Note, tip or reference
-  Incorrect installation
-  Correct installation/test of functionality
-  Observe installation details
-  Cold water
-  Hot water
-  Water flow
-  No water flow
-  Optional/accessories

Intended use

 Single lever mixer tap for use in bathrooms and WCs.

Technical specifications

– Flow at 3 bar pressure: approx. 7.6 l/min

Installation dimensions, refer to page 2

Installation, refer to picture 1 on page 8

 Flush potable water pipes thoroughly before and after installation (observe EN 806 and 1717).

Use only neutrally netting silicone.

Operation, refer to picture 9 on page 9

Servicing, see refer to picture 10 and 11 on page 9

Assemble in reverse order.

– Cartridge nut torque: 12-13 Nm











For spare parts with order numbers, refer to page 11.

 For warranty and care information please refer to the attached **warranty and care instructions**.

 Este manual está dirigido al instalador para el montaje, así como al usuario para el manejo y mantenimiento del producto. Por favor, después de la instalación, este manual se debe entregar al usuario para que lo conserve.

 Ces instructions sont destinées à l'installateur, pour effectuer le montage, et pour l'utilisateur, pour utiliser le produit et procéder à sa maintenance. Après l'installation, veuillez remettre ces instructions à l'utilisateur pour qu'il les conserve.

Símbolos y significado

-  ¡Atención! Advertencia de daños personales o materiales.
-  Indicación, consejo o referencia
-  Montaje erróneo
-  Montaje/comprobación de funcionamiento correctos
-  Observar el detalle de montaje
-  Agua fría
-  Agua caliente
-  Flujo de agua
-  Ningún flujo de agua
-  Opcional/Accesorios

Symboles et leur signification

-  **Attention !** Mise en garde contre les dégâts de personnes et les dégâts matériels.
-  Remarque, conseil ou renvoi
-  Montage incorrect
-  Montage correct/contrôle fonctionnel
-  Respecter le détail de montage
-  Eau froide
-  Eau chaude
-  Débit d'eau
-  Pas de débit d'eau
-  Option/accessoires

Uso previsto

 Mezclador monomando para la utilización en el baño y en el WC.

Domaine d'utilisation

 Mitigeur monocommande pour utilisation dans la salle de bains et les WC.

Datos técnicos

– Paso con una presión de caudal de 3 bares:
aprox. 7,6 l/min.

Caractéristiques techniques

– Débit à une pression d'écoulement de 3 bar :
env. 7,6 l/mn

Medidas de montaje, véase página 2

Cotes de montage, voir page 2

Instalación, véase imagen 1 en la página 8

 Lavar minuciosamente las tuberías de agua potable antes y después de la instalación (observar EN 806 y 1717).
Utilizar exclusivamente silicona de reticulación neutra.

Installation, voir figure 1 à la page 8

 Rincer soigneusement les conduites d'eau potable avant et après l'installation (respecter les normes EN 806 et 1717).
N'utiliser que du silicone à réticulation neutre.

Manejo, véase imagen 9 en la página 9

Utilisation, voir figure 9 à la page 9

Mantenimiento, véase imágenes 10 y 11 en la página 9

Maintenance, voir figures 10 et 11, page 9

El montaje se efectúa en el orden inverso.
– Par de apriete de la tuerca de fijación del cartucho: 12-13 Nm

Le montage s'effectue dans l'ordre inverse de la dépose.
– Couple de serrage écrou de cartouche : 12-13 Nm

Piezas de recambio con números de pedido, véase página 11.

Pièces de rechange avec numéros de commande, voir page 11.

 En el pasaporte de mantenimiento y garantía adjunto encontrará indicaciones sobre la **manual de mantenimiento y tarjeta de garantía.**

 Les consignes relatives à la garantie et à l'entretien figurent sur la **instructions d'entretien et carte de garantie** jointe.

 Il presente manuale è indirizzato agli installatori per il montaggio nonché agli utilizzatori per l'uso e la manutenzione del prodotto. Consegnarlo all'utilizzatore dopo l'installazione affinché lo custodisca.

Simboli e significato

 **Attenzione!** Pericolo di lesioni o danni materiali.

 Avvertenza, consiglio o rimando

 Montaggio errato

 Montaggio corretto/verifica del funzionamento

 Prestare attenzione al dettaglio di montaggio

 Acqua fredda

 Acqua calda

 Flusso d'acqua

 Nessun flusso d'acqua

 Opzionale/accessorio

Scopo d'uso

 Miscelatore monocomando per l'utilizzo in bagno e WC.

Dati tecnici

– Portata con pressione di flusso di 3 bar:
circa 7,6 l/min

Ingombro, vedi pagina 2

Installazione, vedi dalla figura 1 a pagina 8

 Prima e dopo l'installazione lavare con acqua abbondante le condotte di acqua potabile (osservare EN 806 e 1717).

Utilizzare solo silicone neutro.

Uso, vedi figura 9 a pagina 9

Manutenzione, vedi figura 10 e 11 a pagina 9

Eseguire il montaggio in ordine inverso.

– Coppia del dado della cartuccia: 12-13 Nm

Ricambi con numero d'ordine, vedi pagina 11.

 Indicazioni relative alla garanzia e al trattamento vanno desunte dalle **istruzioni di manutenzione e certificato di garanzia**.

 Deze handleiding is bestemd voor zowel de installateur voor de montage alsook voor de gebruiker voor het gebruik en het onderhoud van het product. Gelieve na de installatie door te geven aan de gebruiker om te bewaren.

Symbolen en betekenis

 **Opgepast!** Gevaar voor letsel of schade.

 Opmerking, tip of referentie

 Verkeerde montage

 Correcte montage/werkingstest

 Montagedetails in acht nemen

 Koud water

 Heet water

 Waterstroom

 Geen waterstroom

 Optioneel/toebehoren

Bestemd gebruik

 Eenhendelmengkraan voor gebruik in badkamer en wc.

Technische gegevens

– Doorstroming bij 3 bar stromingsdruk:
ca. 7,6 l/min

Montageafmetingen, zie pagina 2

Installatie, zie vanaf afbeelding 1 op pagina 8

 Drinkwaterleidingen voor en na de installatie grondig spoelen (volgens EN 806 en 1717).

Uitsluitend neutraal vernette siliconen gebruiken.

Gebruik, zie afbeelding 9 op pagina 9

Onderhoud, zie afbeelding 10 en 11 op pagina 9

Montage in omgekeerde volgorde.

– Aandraaimoment moer voor cartouche:

12-13 Nm

Reserveonderdelen met bestelnummers, zie pagina 11.

 Instructies voor de waarborg en het onderhoud vindt u in de meegeleverde **aanwijzingen voor het onderhoud en garantiebewijs**.

 Tento návod slouží instalatérům při montáži a uživatelům při obsluze a údržbě produktu. Po nainstalování ho předejte uživateli, aby si ho mohl uschovat.

Symbole a význam

Pozor! Výstraha před zraněním a věcnými škodami.



Upozornění, tip nebo odkaz



Nesprávná montáž



Správná montáž / kontrola funkčnosti



Při montáži dbejte na tento detail



Studená voda



Teplá voda



Průtok vody



Žádný průtok vody



Volitelná výbava / příslušenství

Účel použití

Páková směšovací armatura pro použití v koupelnách a WC.

Technické údaje

– Průtok při průtokovém tlaku 3 bary:
cca. 7,6 l/min

Montážní rozměry viz strana 2**Instalace** viz obrázek 1 na straně 8

Potrubí na pitnou vodu před a po instalaci důkladně vypláchněte (postupujte podle EN 806 a 1717).

Používejte pouze neutrální silikon.

Obsluha viz obrázek 9 na straně 9**Údržba**, viz snímky 10 a 11 na straně 9

Montáž probíhá v obráceném pořadí.

– Utahovací moment matice kartuše: 12-13 Nm

Náhradní díly s objednáacími čísly viz strany 11

Pokyny týkající se záruky a péče najdete v příloženém **Návodu k údržbě a záručním listu**.



Instrukcja przeznaczona jest dla instalatora, zapewniając pomoc w zakresie montażu oraz dla użytkownika, informując go o sposobie obsługi i konserwacji produktu. Po instalacji należy przekazać instrukcję użytkownikowi, aby ją u siebie przechowywał.

Symbole i znaczenie

Uwaga! Ostrzeżenie przed szkodami osobowymi i materialnymi.



Informacja, dobra rada lub odsyłacz



Niewłaściwy montaż



Właściwy montaż / kontrola funkcjonowania



Należy stosować się do danych, dotyczących montażu



Woda zimna



Woda gorąca



Strumień wody



Brak strumienia wody



Opcje / Osprzęt

Przeznaczenie

Bateria jednouchwytywa do stosowania w łazience i WC.

Dane techniczne

– Przepływ w przypadku ciśnienia hydraulicznego 3 bar: około 7,6 l/min

Wymiary zabudowy, patrz strona 2**Instalacja**, patrz rys. 1 na stronie 8

Przed instalacją i po instalacji należy gruntownie przepłukać przewody, prowadzące wodę pitną (należy stosować się do EN 806 i 1717).

Należy wykorzystywać wyłącznie silikon, ulegający naturalnemu usieciowaniu.

Obsługa, patrz rys. 9 na stronie 9**Konserwacja**, patrz rys. 10 i 11 na stronie 9

Montaż w odwrotnej kolejności.

– Moment obrotowy dokręcenia nakrętki głowicy: 12-13 Nm

Części zamienne z numerami zamówienia, patrz strona 11.

Informacje dotyczące gwarancji dostępne są w dołączonej **karcie pielęgnacyjno-gwarancyjnej**.

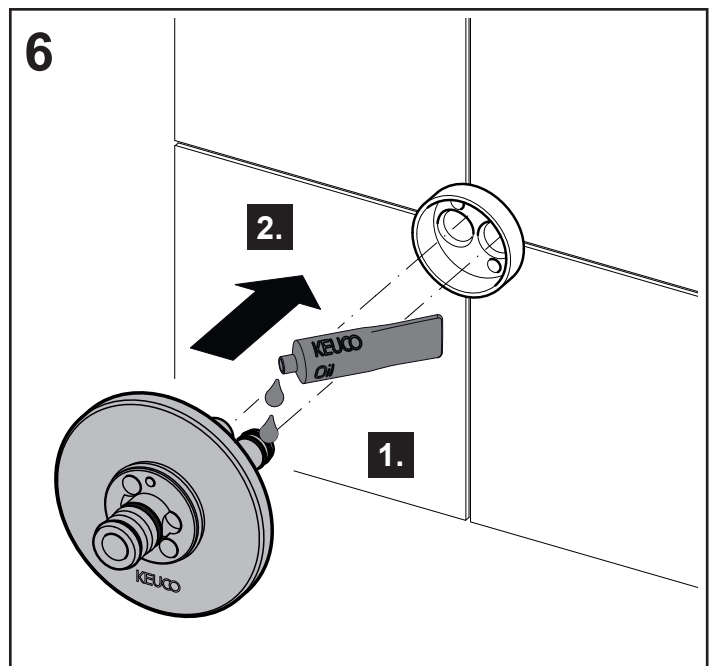
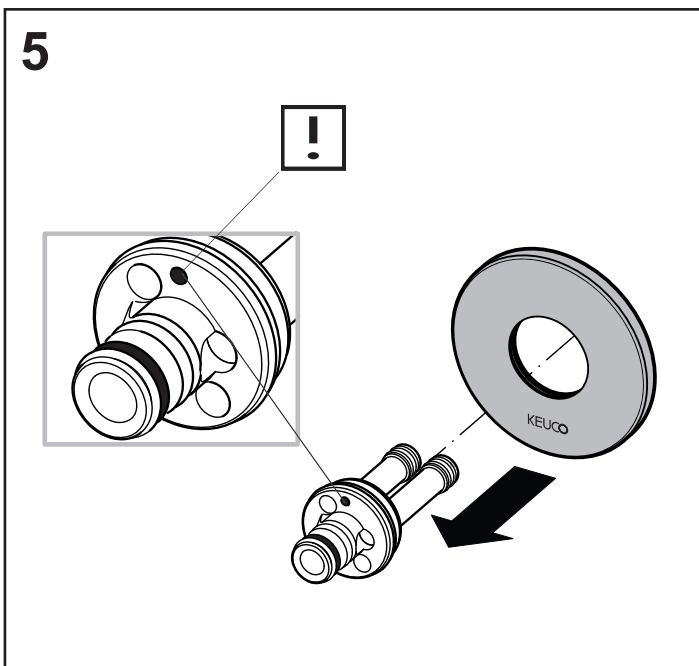
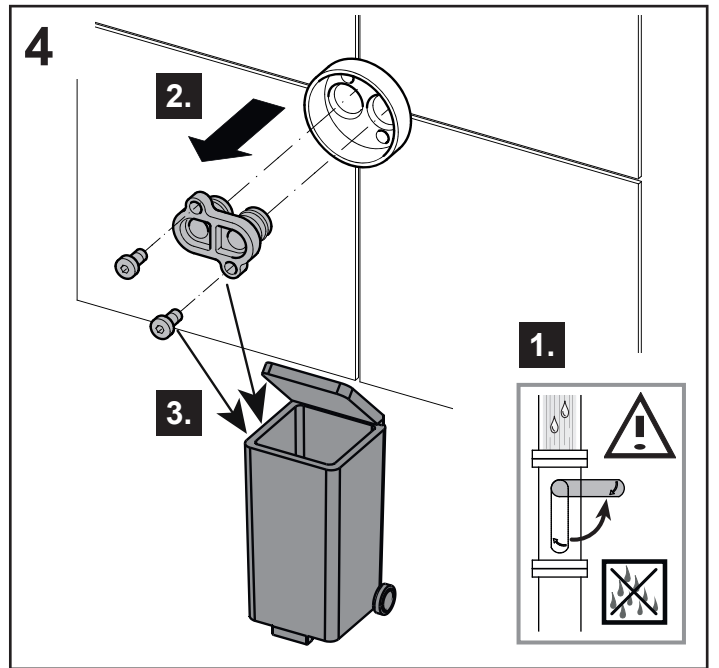
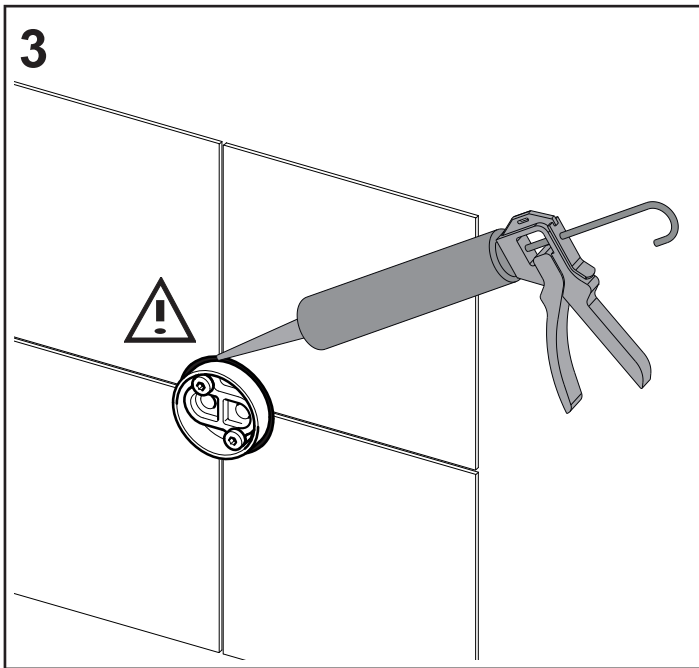
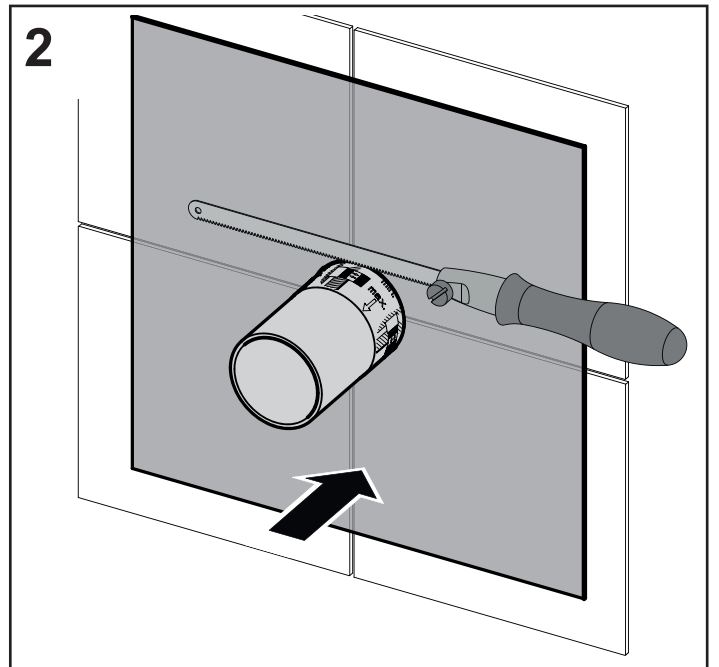
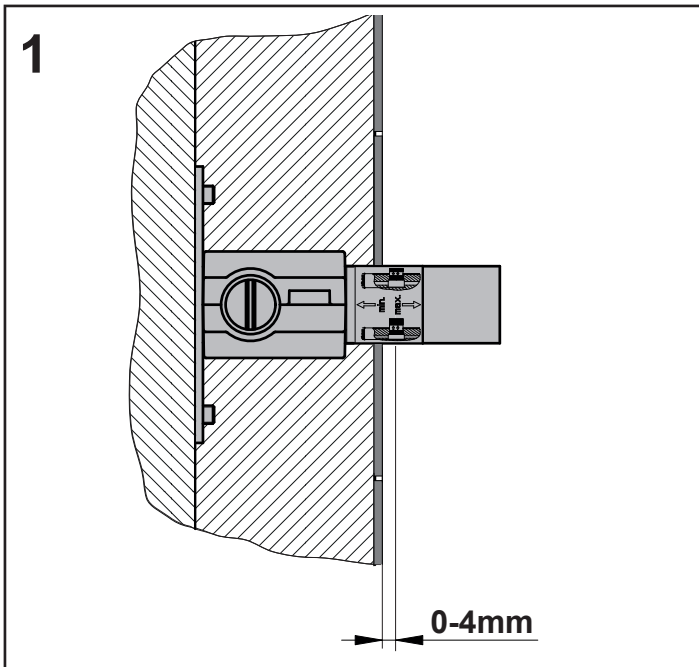

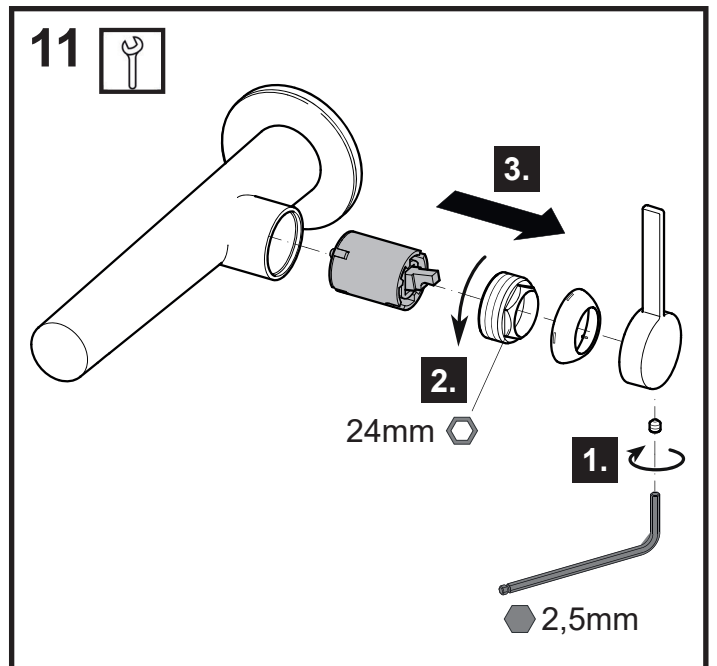
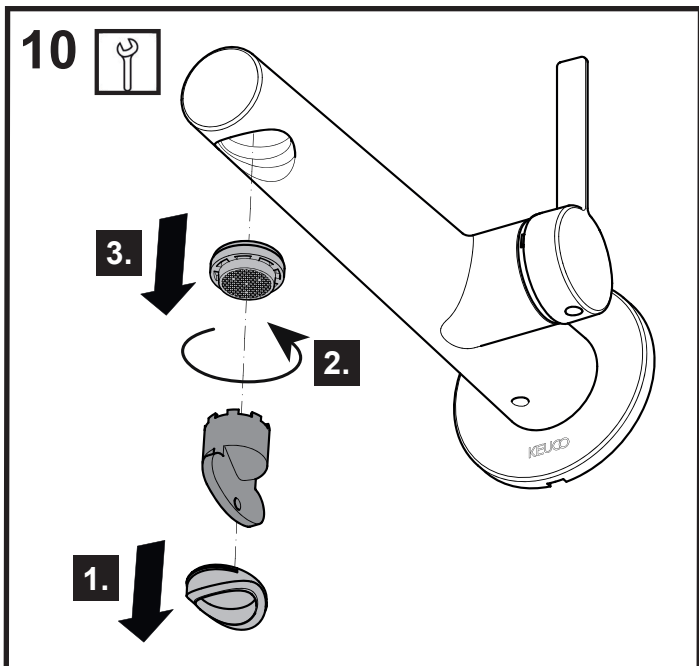
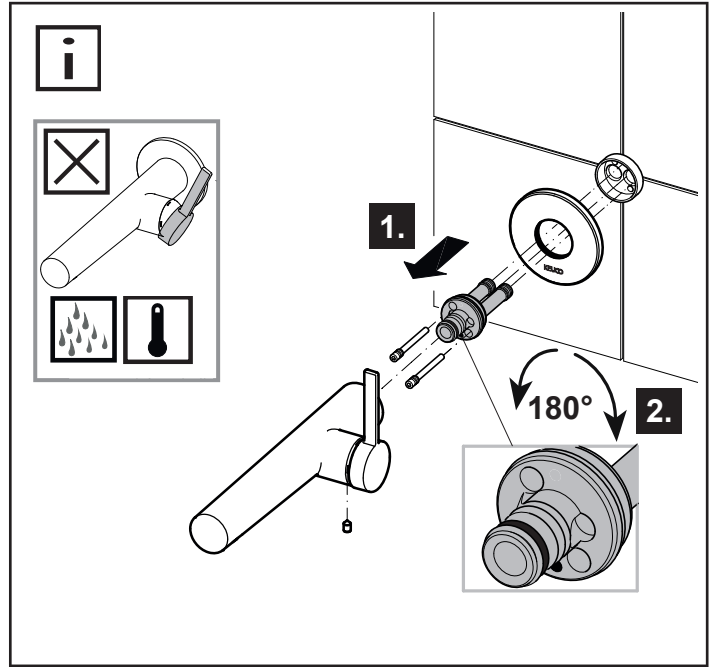
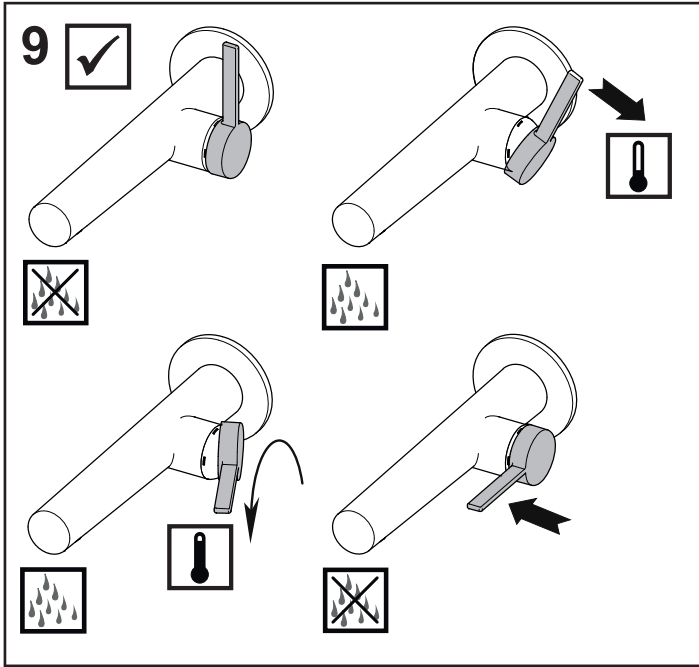
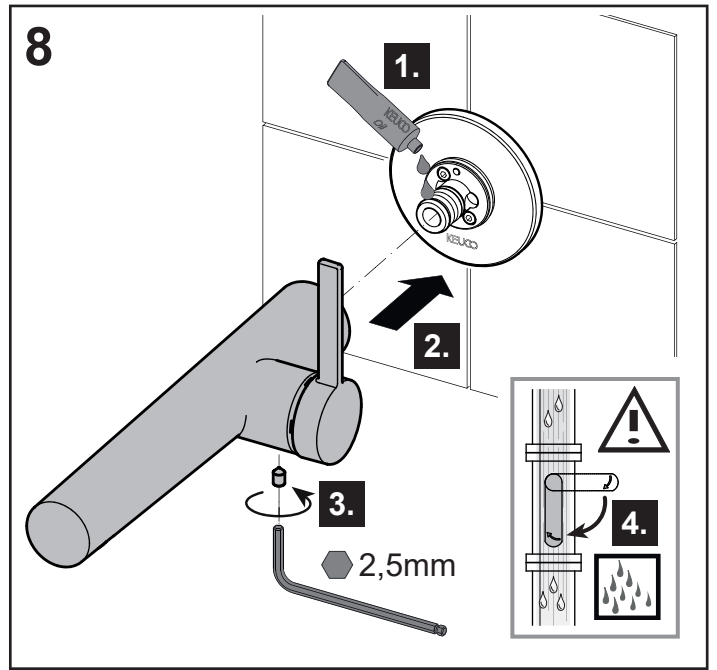
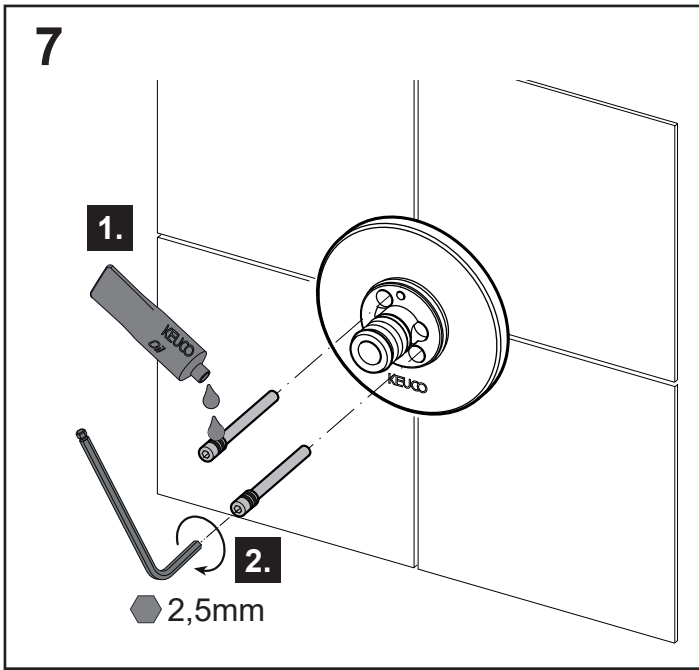



A series of 20 horizontal lines spanning the width of the page, providing a template for handwriting practice.

DE Ersatzteile

FR Pièces de rechange

CS Náhradní díly

EN Spare parts

IT Ricambi

PL Części zamienne

ES Piezas de recambio

NL Reserveonderdelen

RU Запчасти

