

Edition 11

31256300100 Waschtischunterbau

PRODUKT



ZEICHNUNG

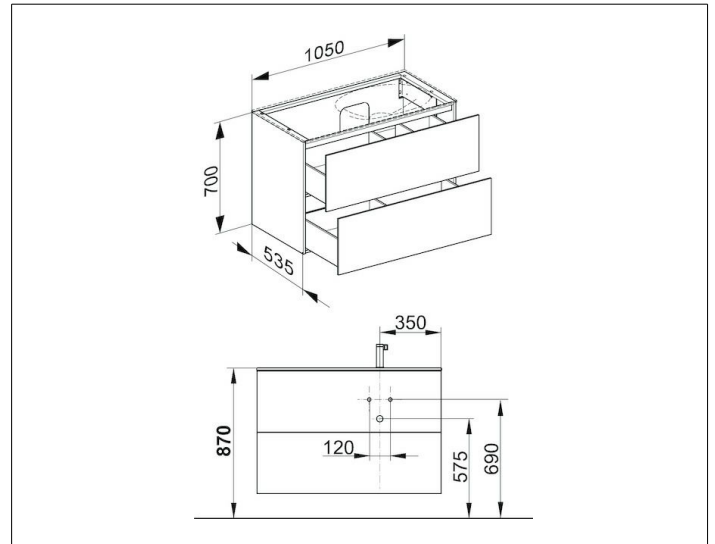

EEK: F , 7 kWh/1000h

OBERFLÄCHE

weiß/Glas weiß

ABMESSUNG

1050 x 700 x 535 mm