

Edition 400

31779450000 Sockelpaket

PRODUKT



ZEICHNUNG

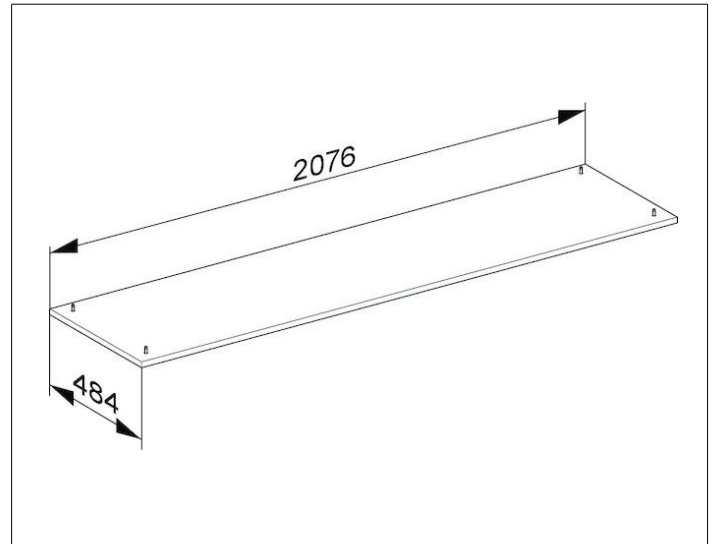

OBERFLÄCHE

cashmere/cashmere

ABMESSUNG

2076 x 25 x 484 mm