

Edition 11

31166890000 Waschtischunterbau

PRODUKT

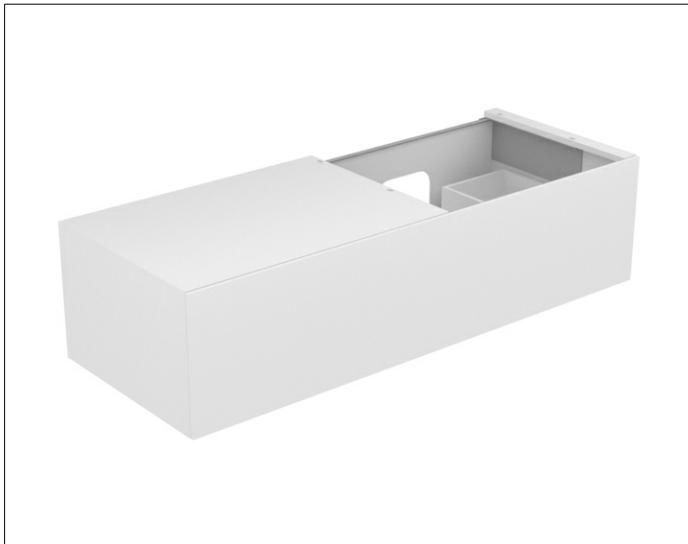

ZEICHNUNG

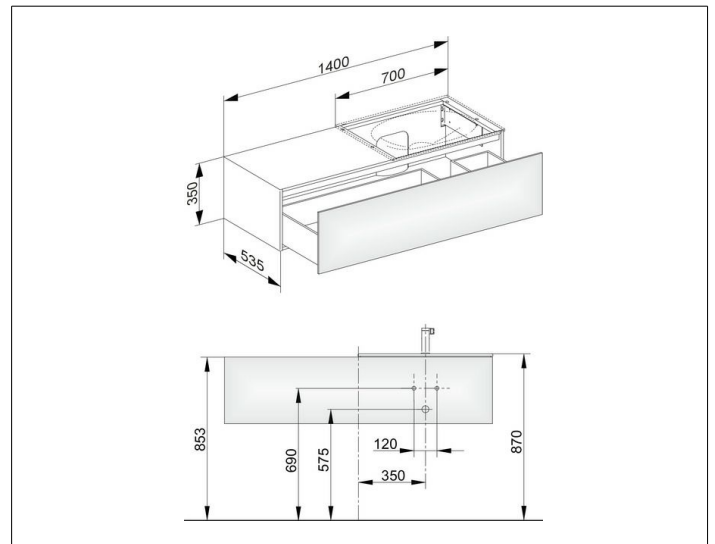

OBERFLÄCHE

Eiche-hell Furnier/Eiche-hell Furnier

ABMESSUNG

1400 x 350 x 535 mm