

Edition 400

31720110001 Mittelschrank

PRODUKT



ZEICHNUNG

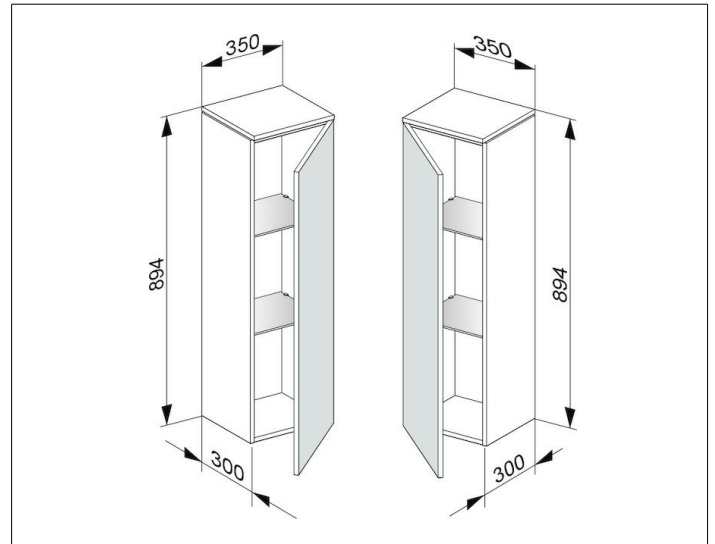

OBERFLÄCHE

anthrazit/Glas anthrazit klar

ABMESSUNG

350 x 894 x 300 mm