

Edition 11

31256380100 Waschtischunterbau

**PRODUKT**



**ZEICHNUNG**

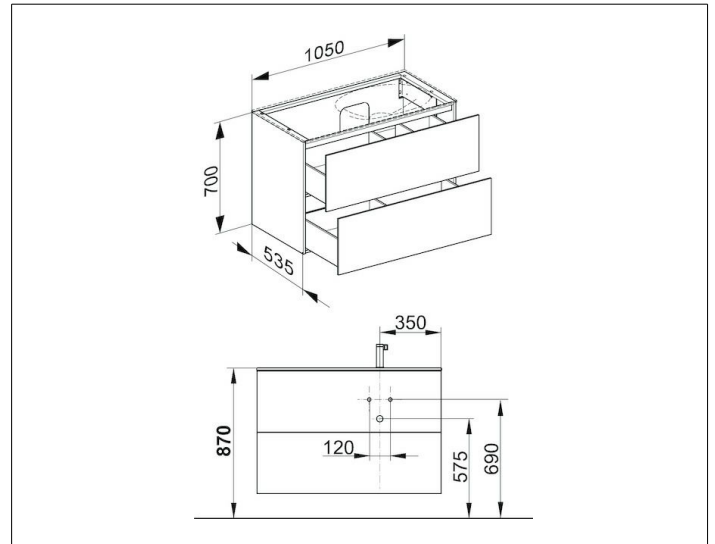

EEK: F , 7 kWh/1000h

**OBERFLÄCHE**

weiß/weiß

**ABMESSUNG**

1050 x 700 x 535 mm