

Edition 11

31166180000 Waschtischunterbau

PRODUKT

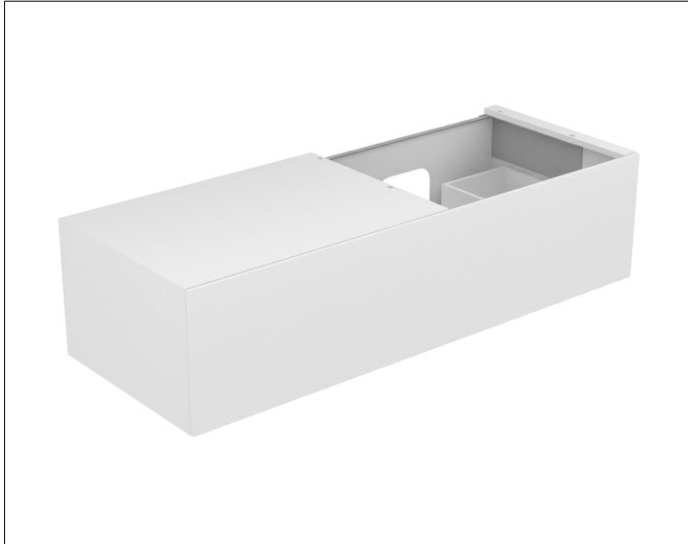

ZEICHNUNG

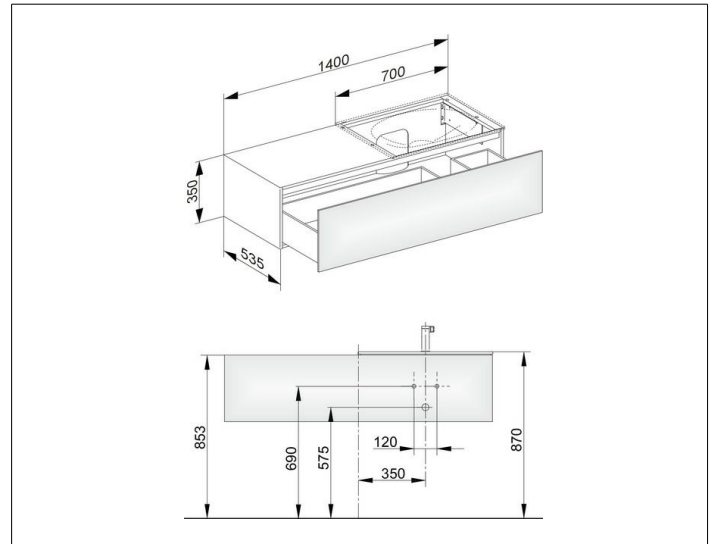

OBERFLÄCHE

cashmere/Glas cashmere

ABMESSUNG

1400 x 350 x 535 mm