

Edition 400

31769450000 Sockelpaket

PRODUKT



ZEICHNUNG

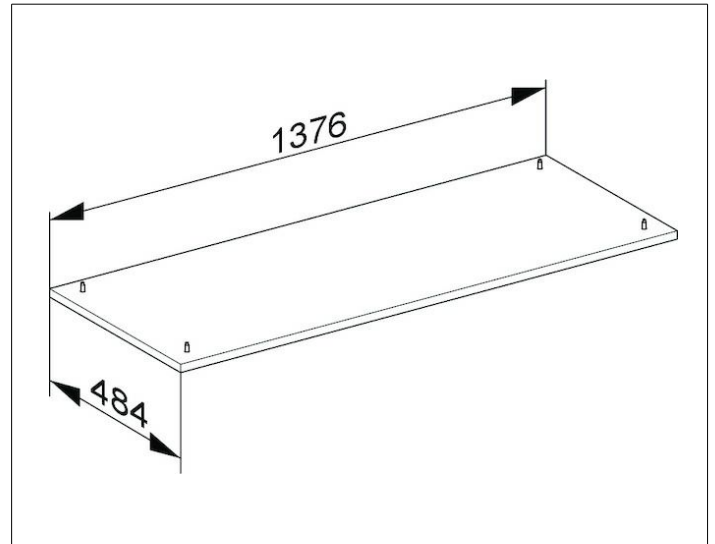

OBERFLÄCHE

cashmere/cashmere

ABMESSUNG

1376 x 25 x 484 mm