

Edition 11

31198280001 Waschtischunterbau

**PRODUKT**



**ZEICHNUNG**

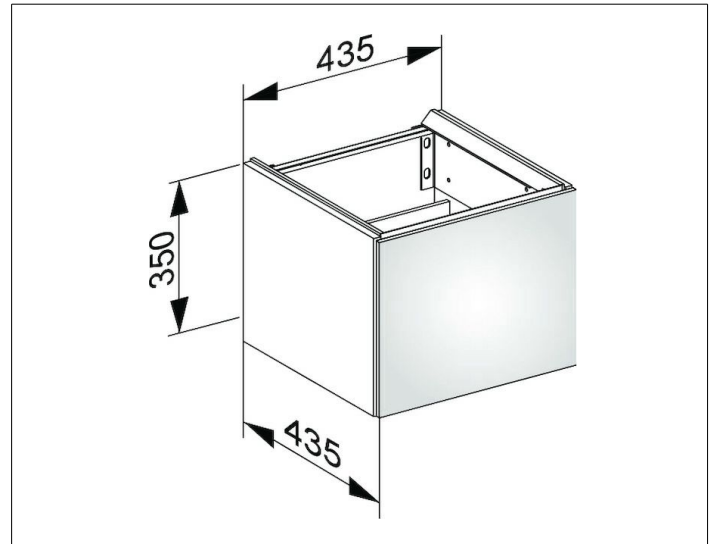

**OBERFLÄCHE**

cashmere/Glas cashmere satiniert

**ABMESSUNG**

435 x 350 x 435 mm