

Edition 400

31720180001 Mittelschrank

PRODUKT



ZEICHNUNG

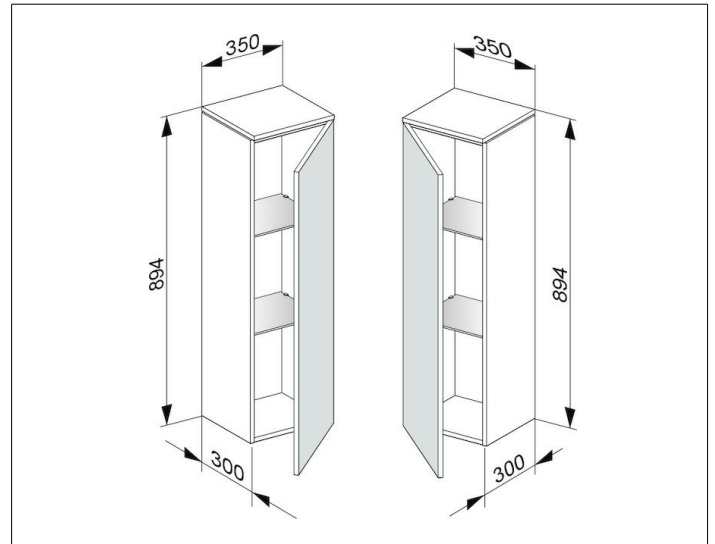

OBERFLÄCHE

cashmere/Glas cashmere klar

ABMESSUNG

350 x 894 x 300 mm