

Edition 400

31759450000 Sockelpaket

PRODUKT



ZEICHNUNG

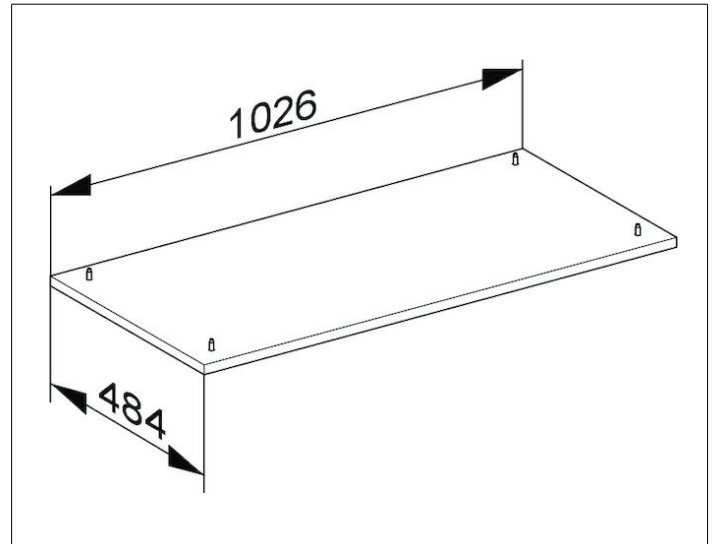

OBERFLÄCHE

cashmere/cashmere

ABMESSUNG

1026 x 25 x 484 mm