

Edition 11

31320189000 Abdeckplatte

**PRODUKT**

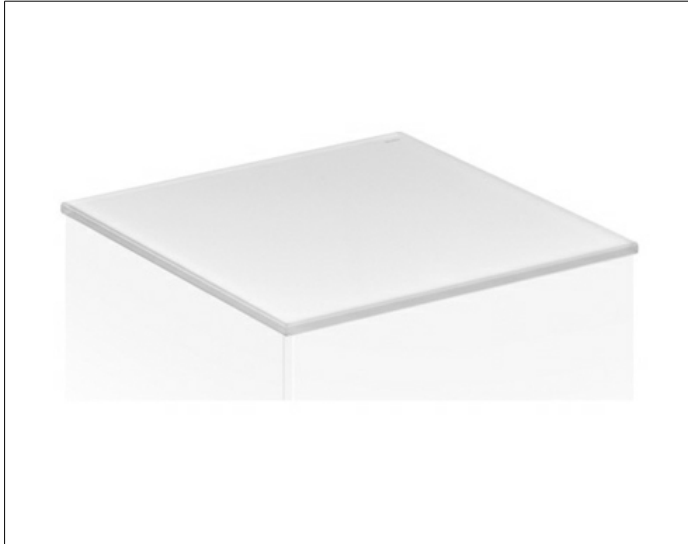

**ZEICHNUNG**

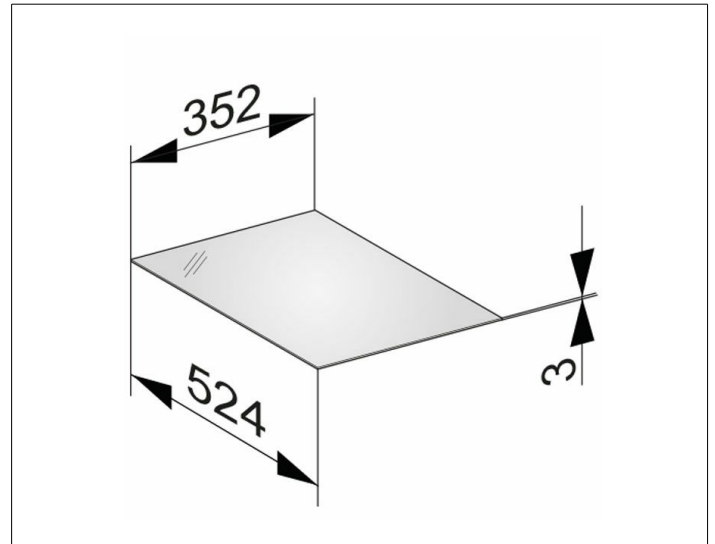

**OBERFLÄCHE**

cashmere/Glas cashmere

**ABMESSUNG**

352 x 3 x 524 mm