

Edition 400

31572180100 Waschtischunterbau

PRODUKT



ZEICHNUNG

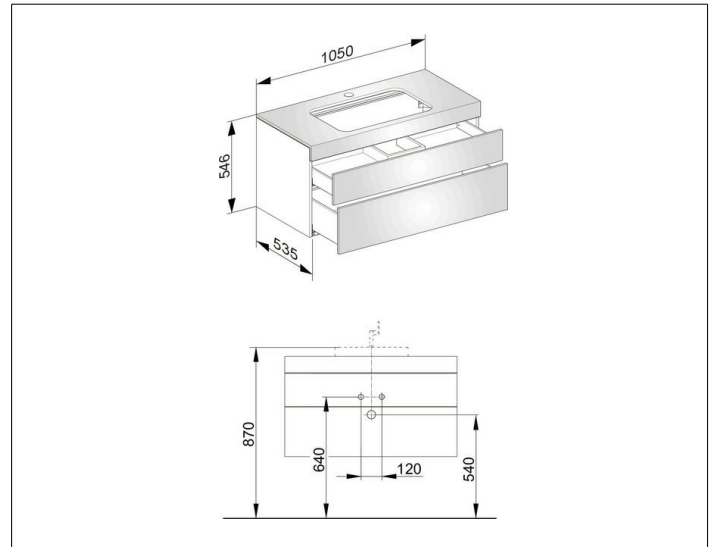

OBERFLÄCHE

cashmere/Glas cashmere klar

ABMESSUNG

1050 x 546 x 535 mm