

Edition 11

31313180000 Modul Unterbauschrank

PRODUKT



ZEICHNUNG

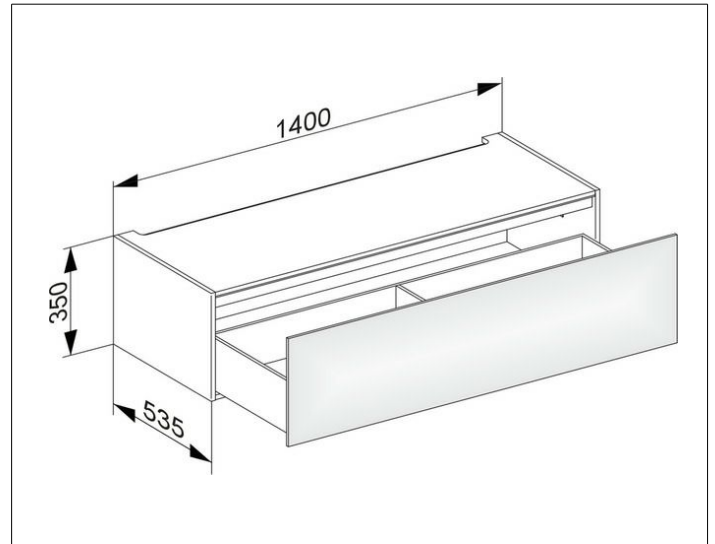

OBERFLÄCHE

cashmere/Glas cashmere

ABMESSUNG

1400 x 350 x 535 mm