

Edition 11

31251180100 Waschtischunterbau

PRODUKT

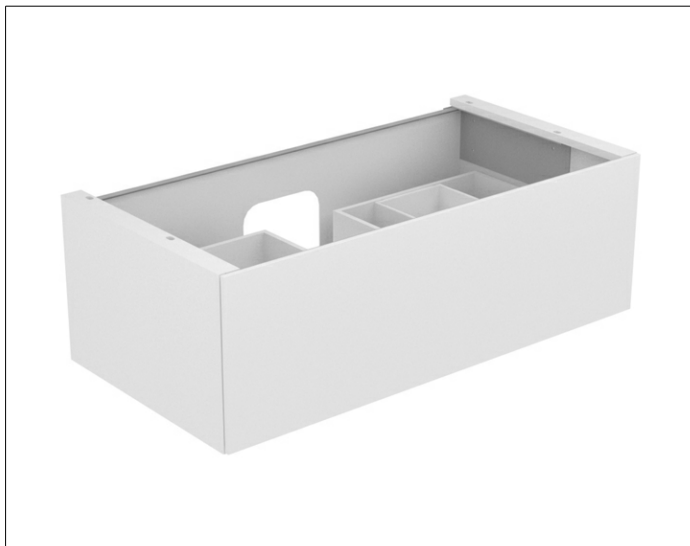

ZEICHNUNG

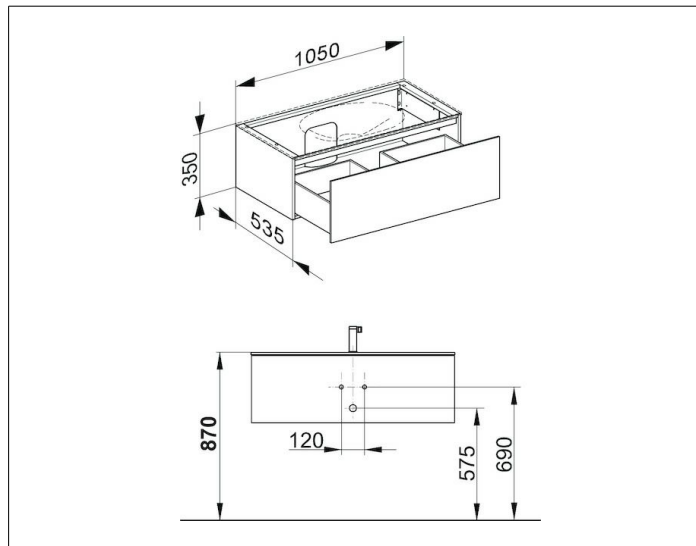

EEK: F ,

OBERFLÄCHE

cashmere/Glas cashmere

ABMESSUNG

1050 x 350 x 535 mm