

Edition 11

31264890000 Waschtischunterbau

**PRODUKT**

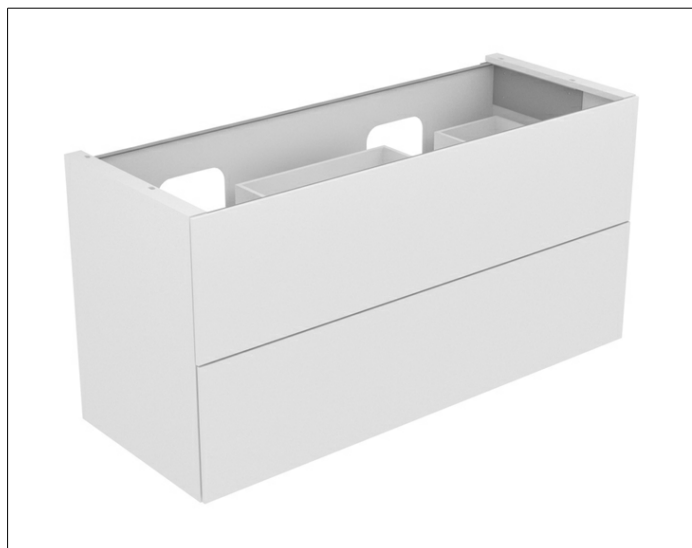

**ZEICHNUNG**

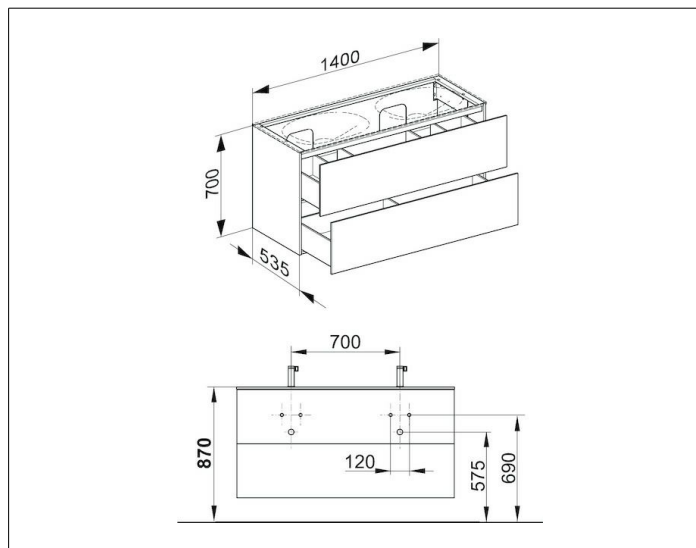

**OBERFLÄCHE**

Eiche-hell Furnier/Eiche-hell Furnier

**ABMESSUNG**

1400 x 700 x 535 mm