

Royal Modular 2.0
800100051100100 Spiegelschrank

PRODUKT

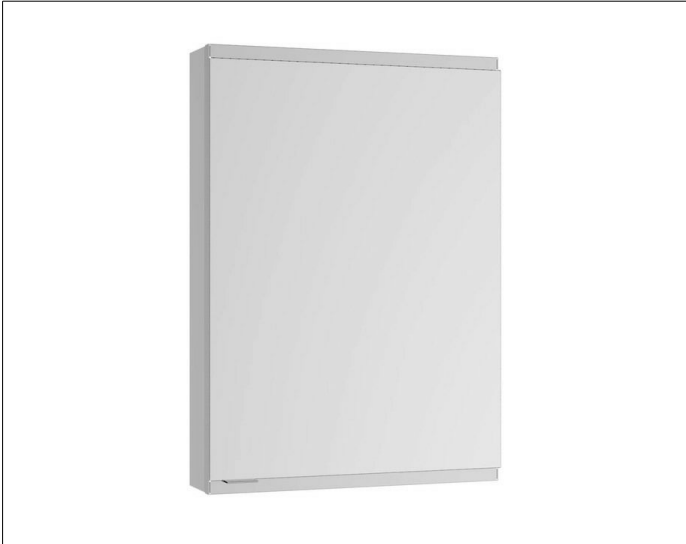

ZEICHNUNG

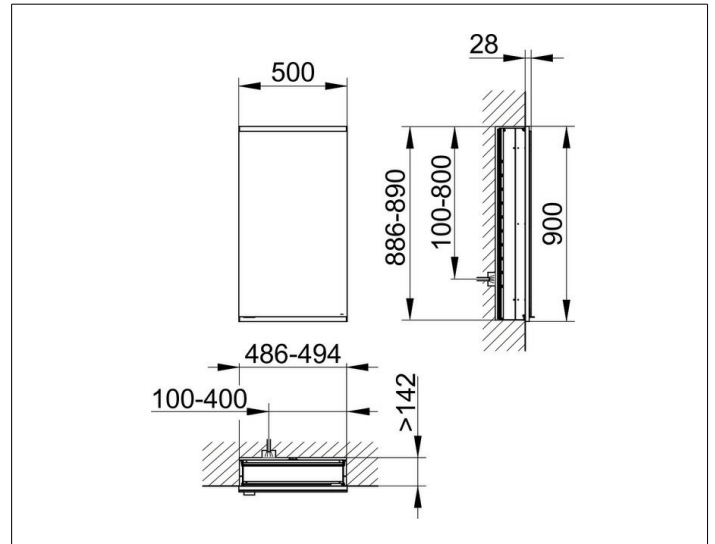

OBERFLÄCHE

silber-eloxiert

ABMESSUNG

500 x 900 x 160 mm