

Edition 11

31341280000 Waschtischunterbau

PRODUKT

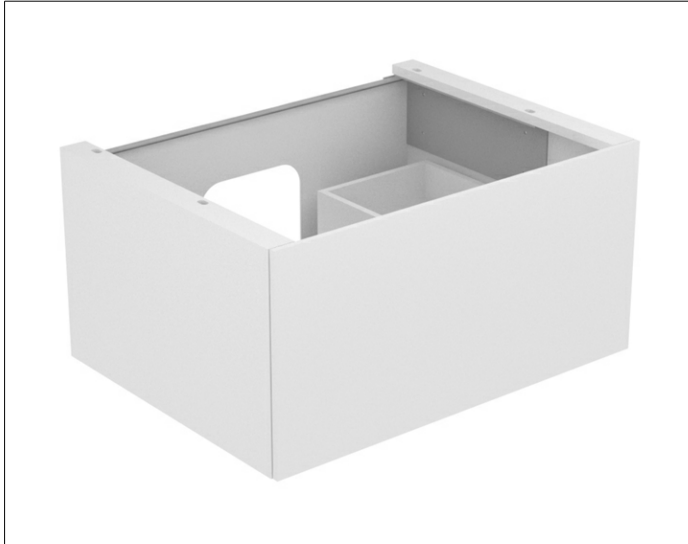

ZEICHNUNG

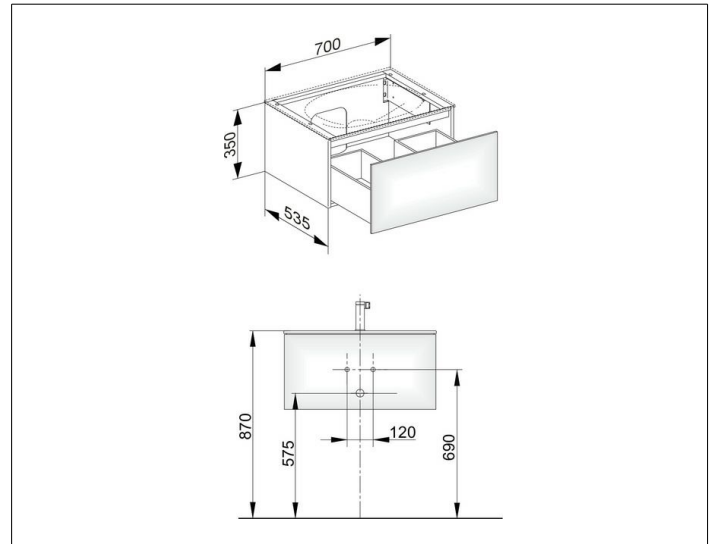

OBERFLÄCHE

cashmere/Glas cashmere satiniert

ABMESSUNG

700 x 350 x 535 mm