

Edition 11

31310390000 Modul Unterbauschrank

**PRODUKT**

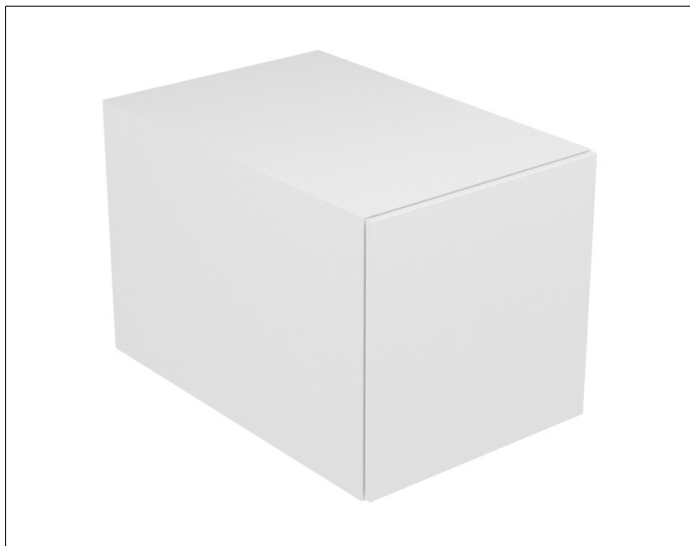

**ZEICHNUNG**

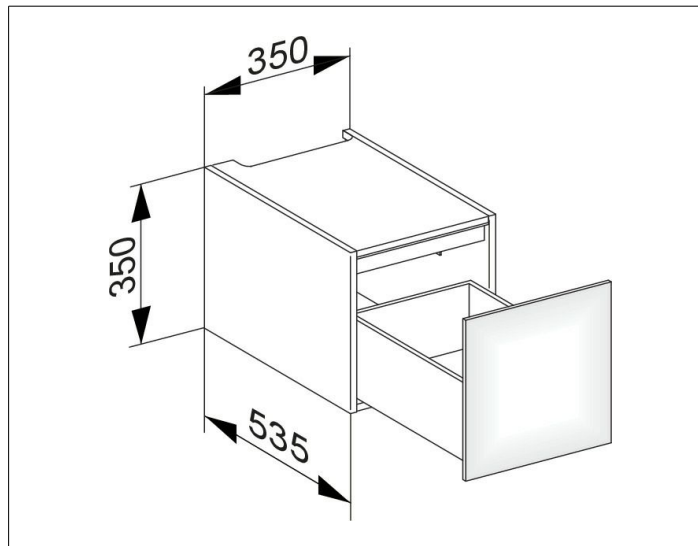

**OBERFLÄCHE**

anthrazit/anthrazit

**ABMESSUNG**

350 x 350 x 535 mm