

Edition 11

31322189002 Abdeckplatte

**PRODUKT**

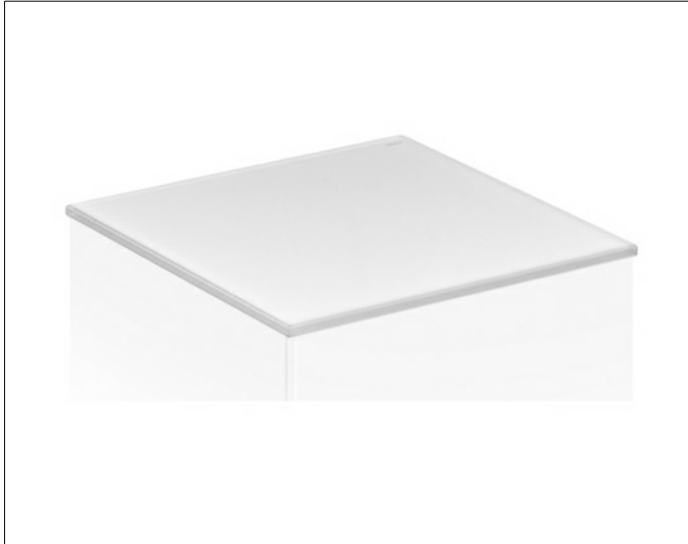

**ZEICHNUNG**

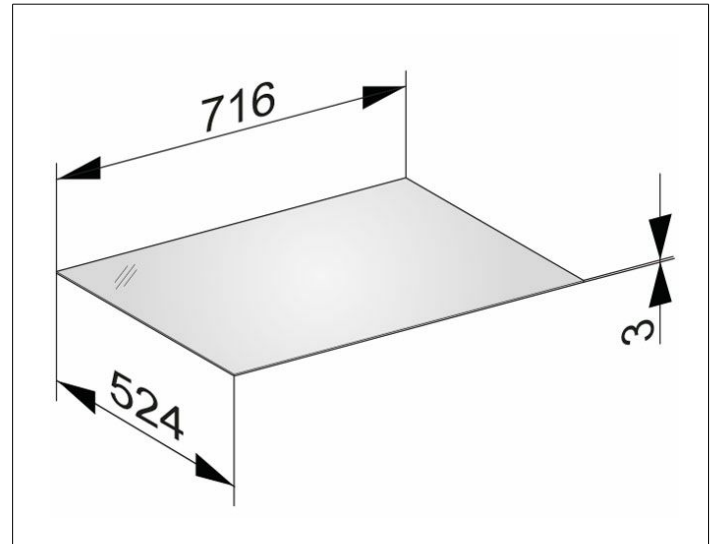

**OBERFLÄCHE**

cashmere/Glas cashmere

**ABMESSUNG**

716 x 3 x 524 mm