

Edition 400

31541390000 Waschtischunterbau

PRODUKT



ZEICHNUNG

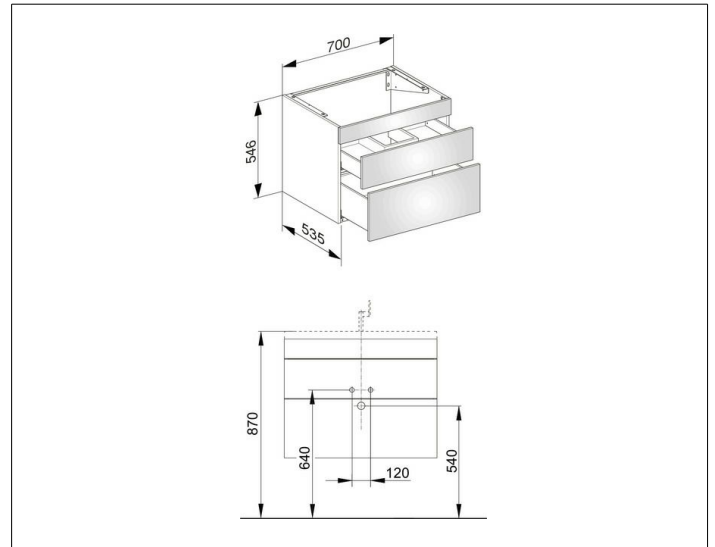

OBERFLÄCHE

anthrazit/anthrazit

ABMESSUNG

700 x 546 x 535 mm