

Edition 11

31264110100 Waschtischunterbau

**PRODUKT**

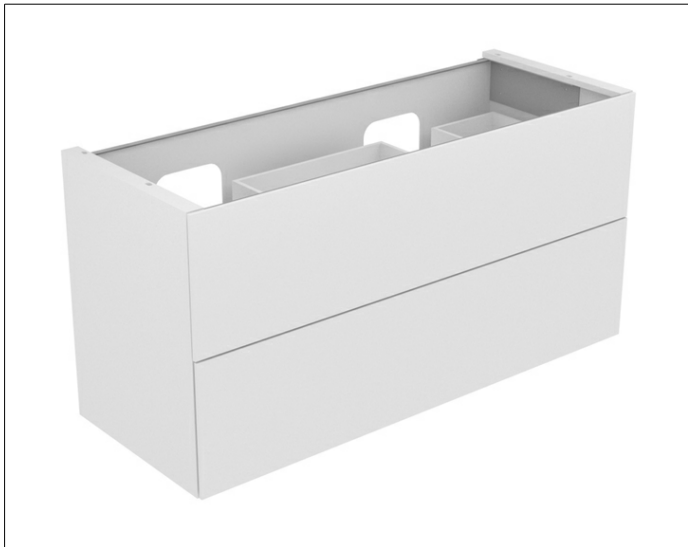

**ZEICHNUNG**

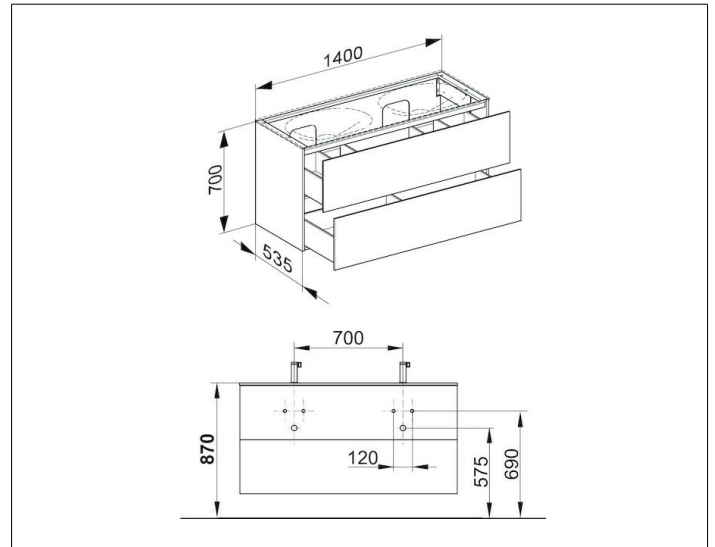

EEK: F , 10 kWh/1000h

**OBERFLÄCHE**

anthrazit/Glas anthrazit

**ABMESSUNG**

1400 x 700 x 535 mm