

Edition 11

31310180000 Modul Unterbauschrank

**PRODUKT**

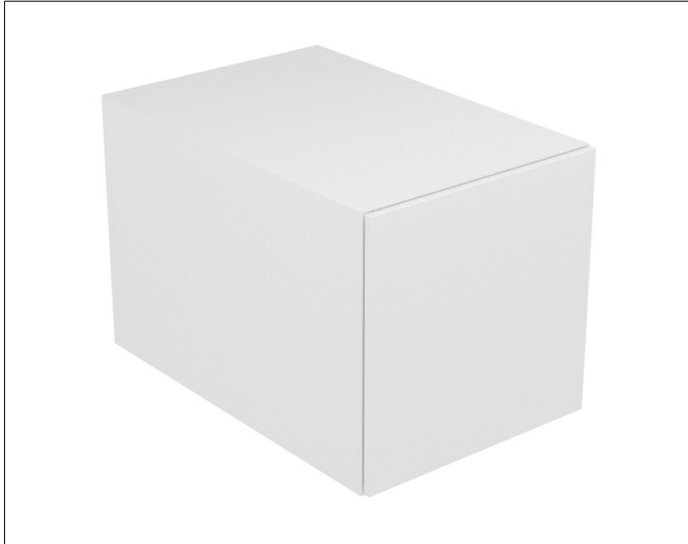

**ZEICHNUNG**

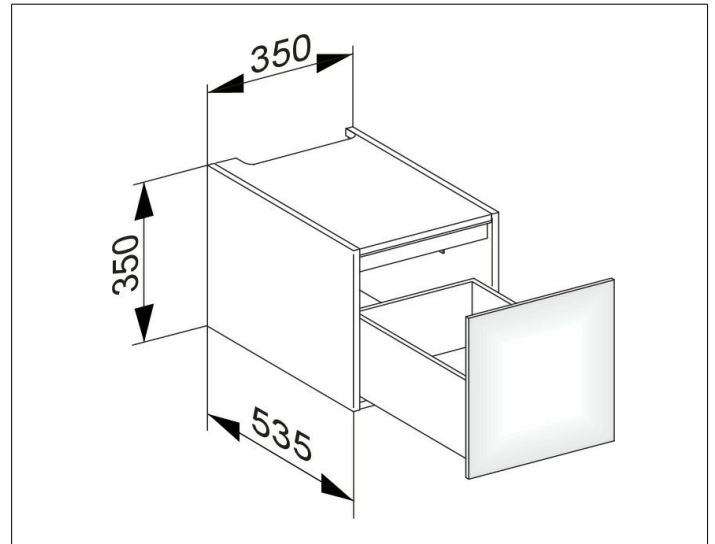

**OBERFLÄCHE**

cashmere/Glas cashmere

**ABMESSUNG**

350 x 350 x 535 mm