

Edition 11

31320289001 Abdeckplatte

PRODUKT

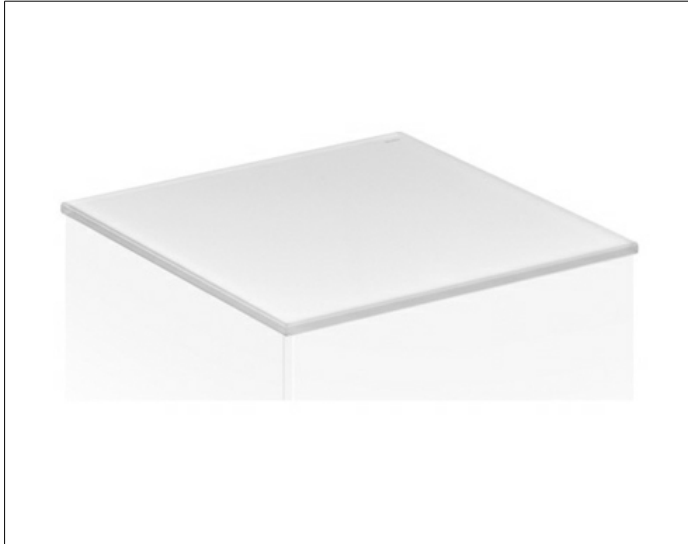

ZEICHNUNG

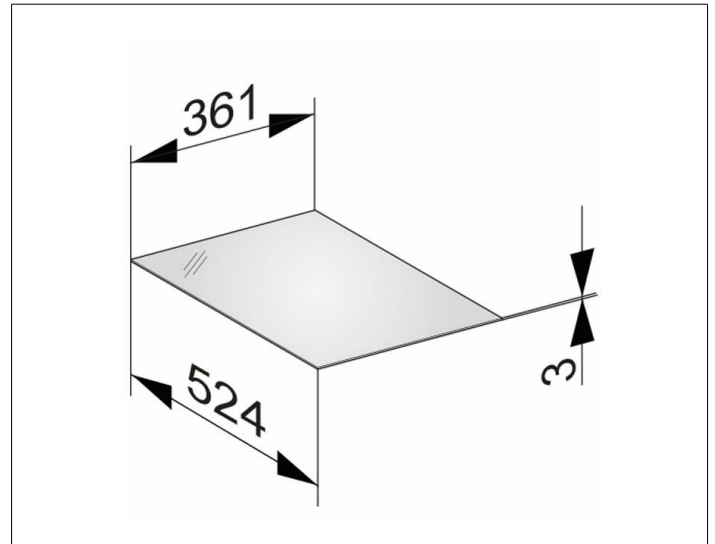

OBERFLÄCHE

cashmere/Glas cashmere satiniert

ABMESSUNG

361 x 3 x 524 mm