

Edition 400

31575390000 Waschtischunterbau

PRODUKT



ZEICHNUNG

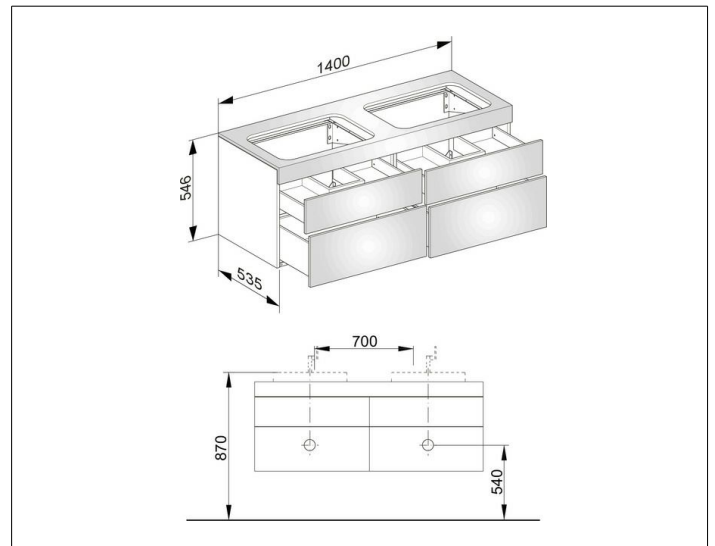

OBERFLÄCHE

anthrazit/anthrazit

ABMESSUNG

1400 x 546 x 535 mm