

Edition 11

31320189002 Abdeckplatte

PRODUKT

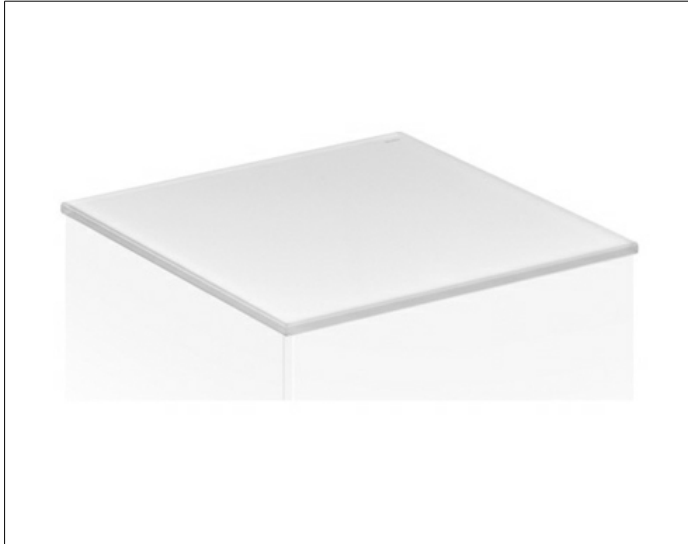

ZEICHNUNG

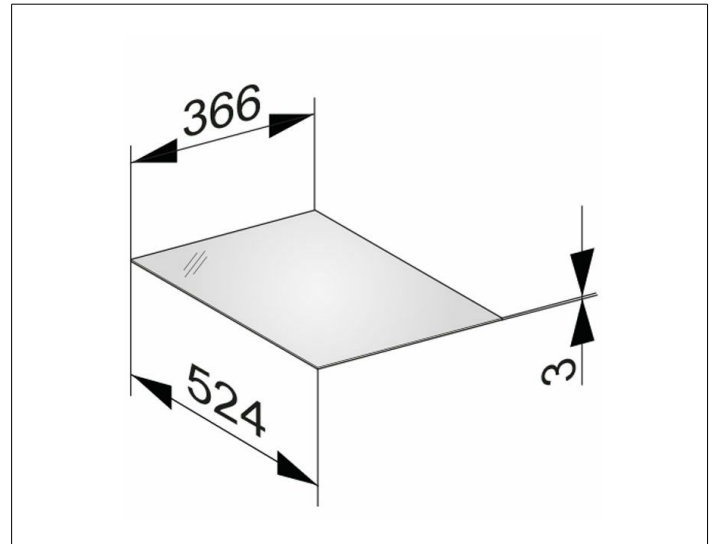

OBERFLÄCHE

cashmere/Glas cashmere

ABMESSUNG

366 x 3 x 524 mm