

Edition 11

31312370000 Modul Unterbauschrank

**PRODUKT**



**ZEICHNUNG**

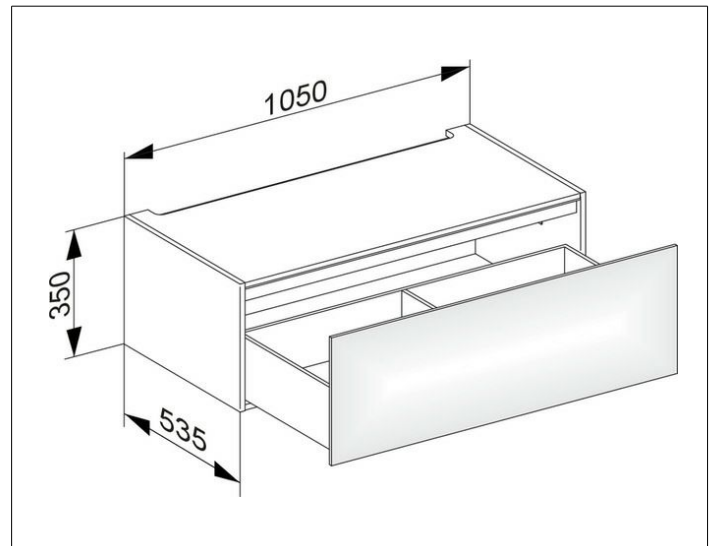

**OBERFLÄCHE**

trüffel/trüffel

**ABMESSUNG**

1050 x 350 x 535 mm