

Edition 11

31261380000 Waschtischunterbau

PRODUKT

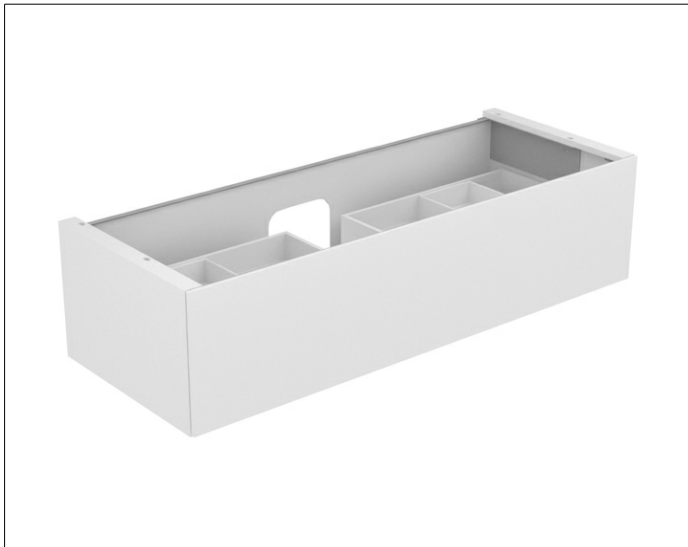

ZEICHNUNG

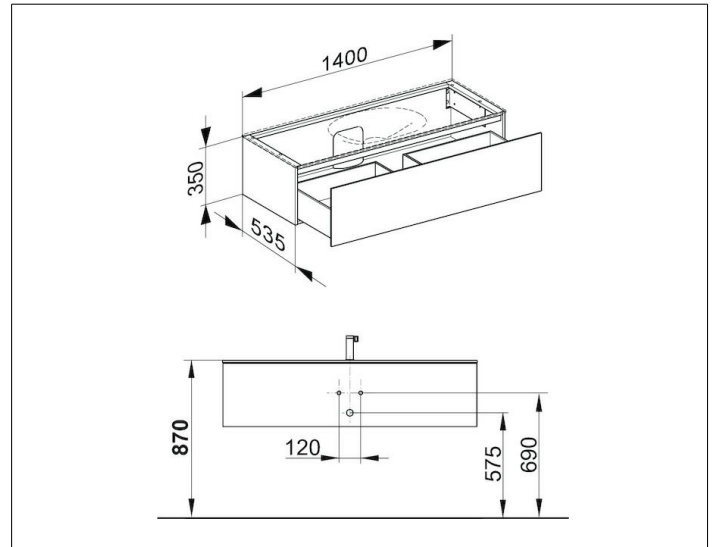

OBERFLÄCHE

weiß/weiß

ABMESSUNG

1400 x 350 x 535 mm