

Edition 400

31759390000 Sockelpaket

PRODUKT



ZEICHNUNG

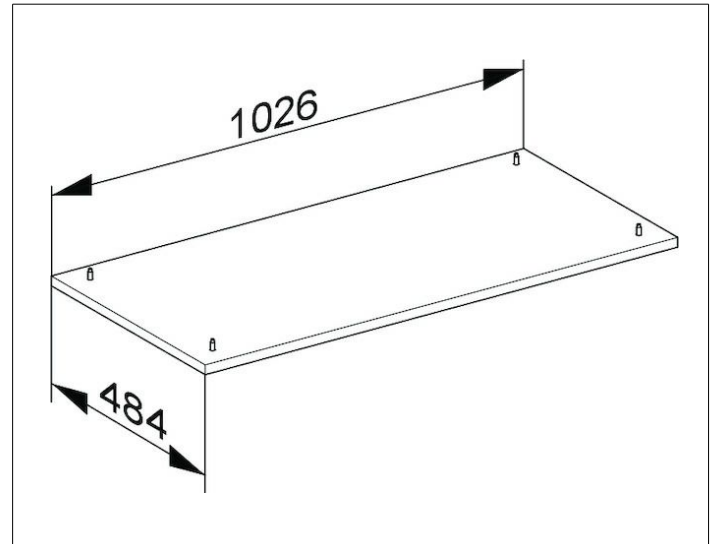

OBERFLÄCHE

anthrazit/anthrazit

ABMESSUNG

1026 x 25 x 484 mm