

Edition 11

31362110000 Waschtischunterbau

PRODUKT



ZEICHNUNG

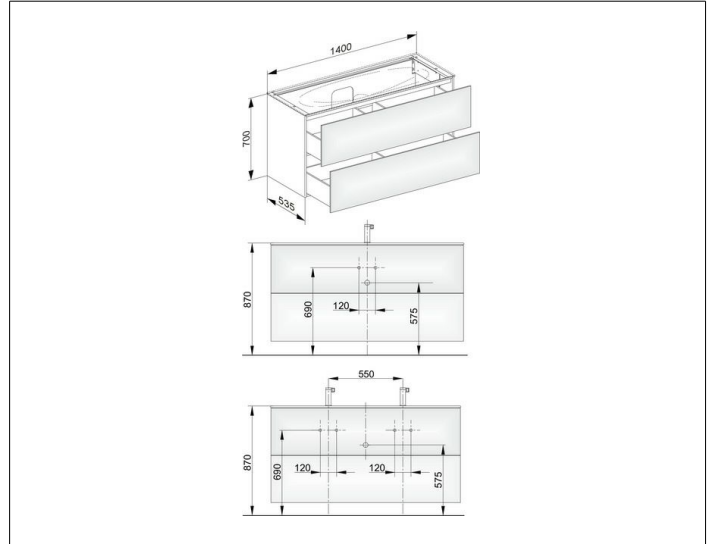

OBERFLÄCHE

anthrazit/Glas anthrazit

ABMESSUNG

1400 x 700 x 535 mm