

Edition 11

31362300000 Waschtischunterbau

PRODUKT



ZEICHNUNG

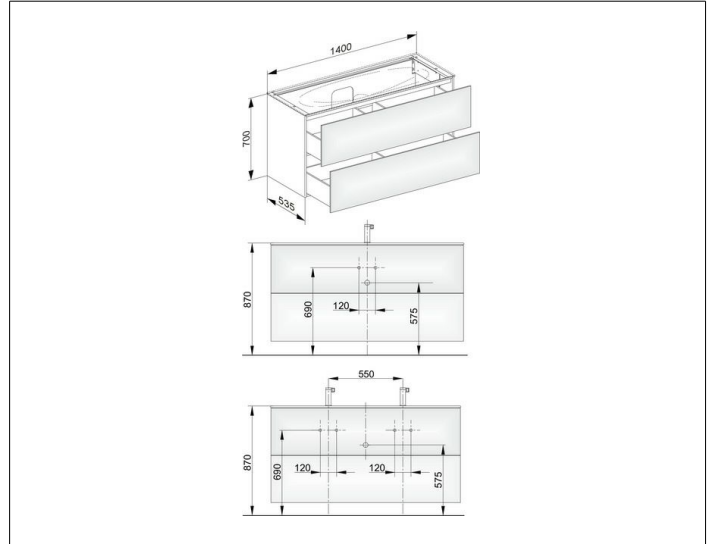

OBERFLÄCHE

weiß/Glas weiß

ABMESSUNG

1400 x 700 x 535 mm