

Edition 11

31341890100 Waschtischunterbau

**PRODUKT**

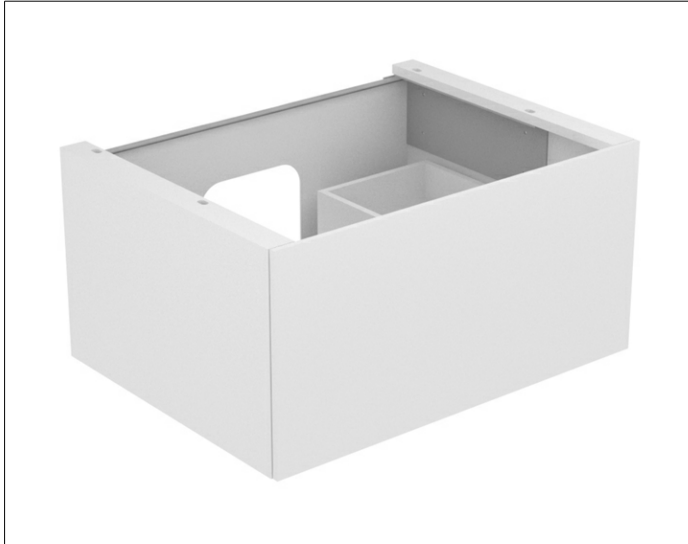

**ZEICHNUNG**

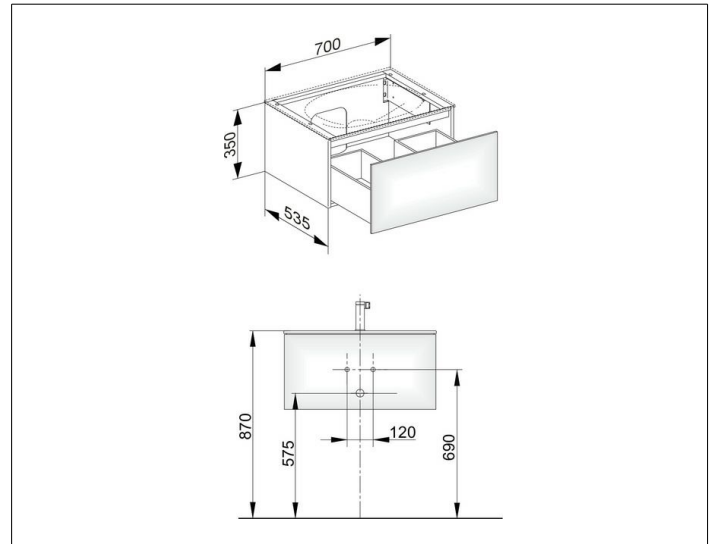

EEK: F , 5 kWh/1000h

**OBERFLÄCHE**

Eiche-hell Furnier/Eiche-hell Furnier

**ABMESSUNG**

700 x 350 x 535 mm