

Edition 11

31324189000 Abdeckplatte

PRODUKT

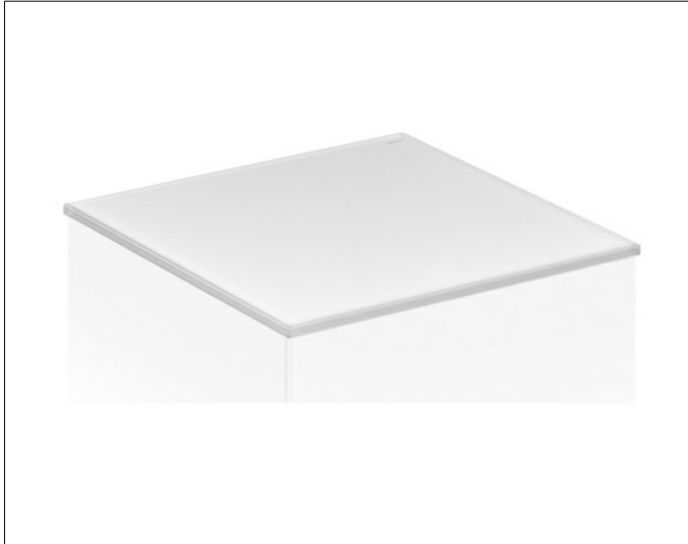

ZEICHNUNG

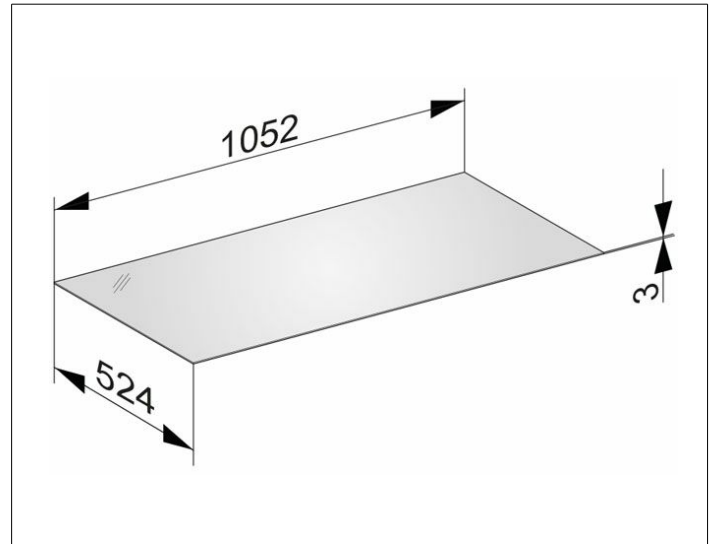

OBERFLÄCHE

cashmere/Glas cashmere

ABMESSUNG

1052 x 3 x 524 mm