

KLUDI MEDI-CARE

34920

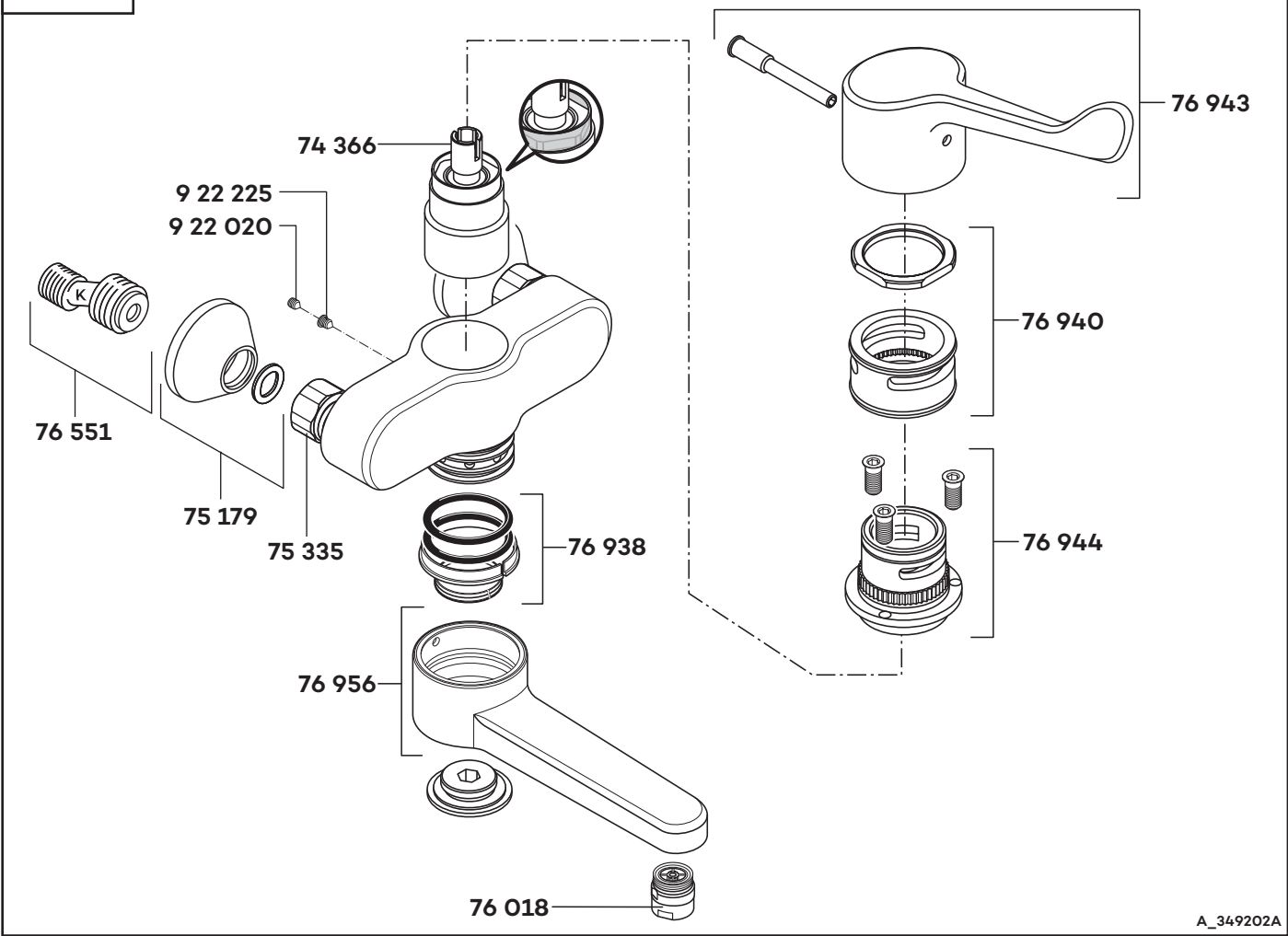

A_349202A

34920	03/06 → Wand-Einhandmischer DN 15	single lever wall mixer DN 15	ééngreeps wandmengkraan 1/2"
74 366	Kartusche, KLUDI MEDI-CARE	cartridge, KLUDI MEDI-CARE	cartouche, KLUDI MEDI-CARE
75 179	Rosette	wall flange	rozet
75 335	Wandarmaturanschluss	wall-fitting connection	wandmengkraan aansluiting
76 018	Care-Strahlregler	Care flow straightener	Care-mondstuk
76 551	S-Anschluss mit Schalldämpfer	S-connection with sound absorber	S-koppeling met geluiddemper
76 938	Dichtungssatz	sealing set	set dichtingen
76 940	Desinfektionskranz	disinfecting rim	desinfectiering
76 943	KLUDI MEDI-CARE, Klinik-Armhebel	KLUDI MEDI-CARE, arm lever for hospital purpose	KLUDI MEDI-CARE, lange hendel
76 944	Spannhülse	fastening cap	spanhuls
76 956	Gussauslauf KLUDI MEDI-CARE	casted spout KLUDI MEDI-CARE	gegoten uitloop KLUDI MEDI-CARE
922 020	Auslaufbefestigungsschraube	fastening screw for spout	bev. schroef voor uitloop
922 225	Nirosta-Schraube	Stainless screw	Nirosta schroef

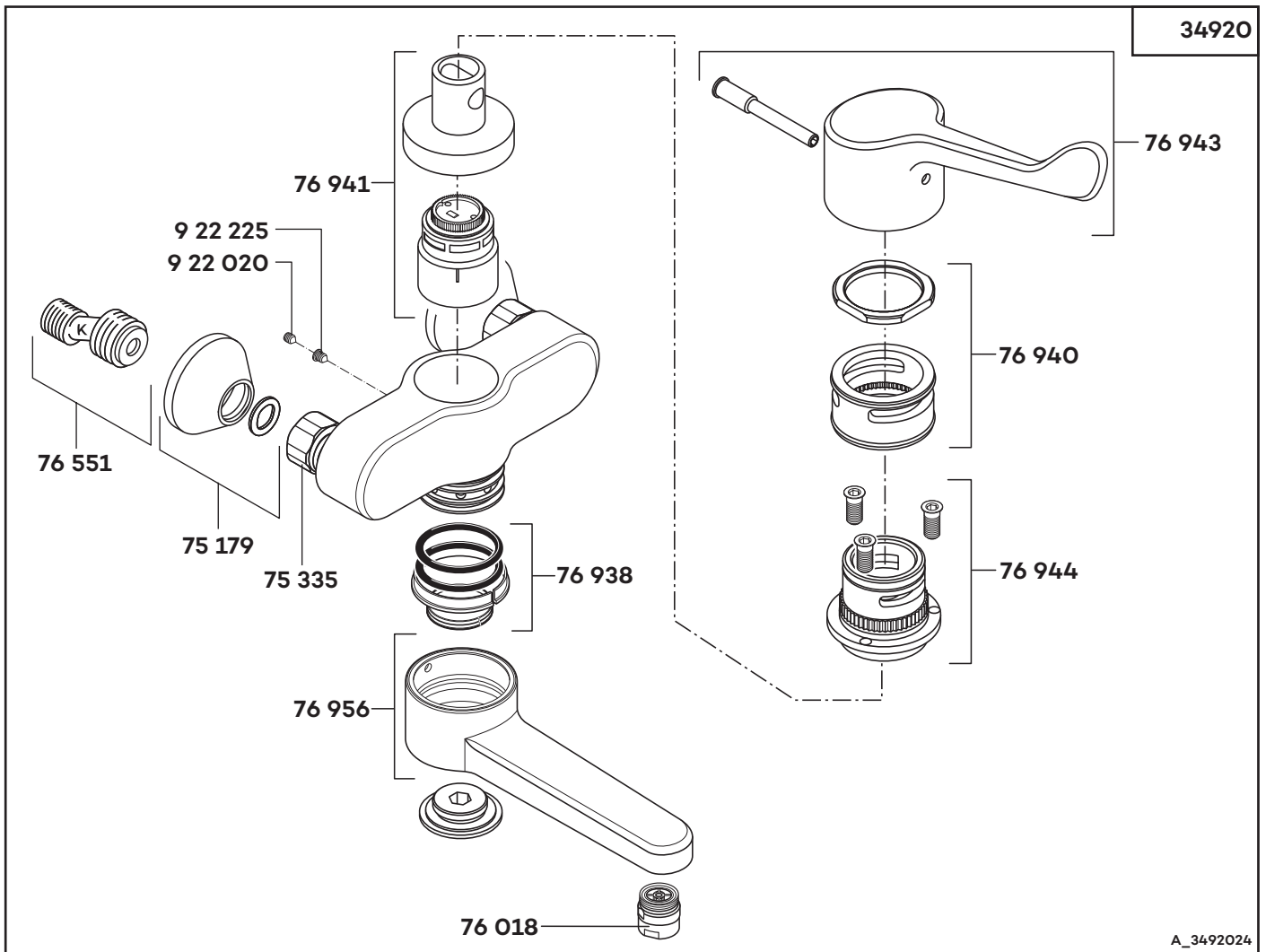

34920	Wand-Einhandmischer DN 15	single lever wall mixer DN 15	ééngreeps wandmengkraan 1/2"
75 179	Rosette	wall flange	rozet
75 335	Wandarmaturanschluss	wall-fitting connection	wandmengkraan aansluiting
76 018	Care-Strahlregler	care flow straightener	Care-mondstuk
76 551	S-Anschluss mit Schalldämpfer	S-connection with sound absorber	S-koppeling met geluiddemper
76 938	Dichtungssatz	sealing set	set dichtingen
76 940	Desinfektionskranz	disinfecting rim	desinfectiering
76 941	Kartusche, KLUDI MEDI-CARE	cartridge, KLUDI MEDI-CARE	cartouche, KLUDI MEDI-CARE
76 943	KLUDI MEDI-CARE, Klinik-Armhebel	KLUDI MEDI-CARE, arm lever for hospital purpose	KLUDI MEDI-CARE, lange hendel
76 944	Spannhülse	fastening cap	spanhuls
76 956	Gussauslauf KLUDI MEDI-CARE	casted spout KLUDI MEDI-CARE	gegoten uitloop KLUDI MEDI-CARE
922 020	Auslaufbefestigungsschraube	fastening screw for spout	bev. schroef voor uitloop
922 225	Nirosta-Schraube	Stainless screw	Nirosta schroef