

XX = AA, AD,

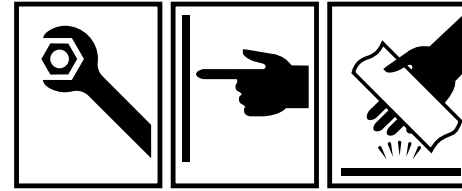
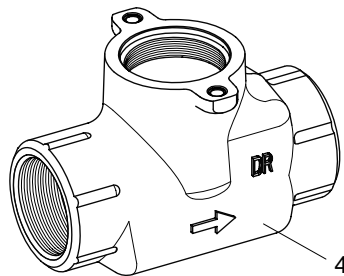
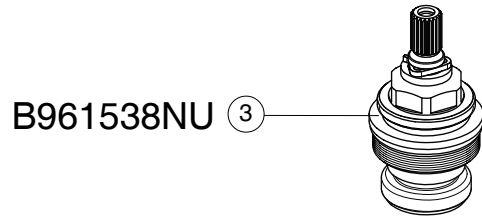
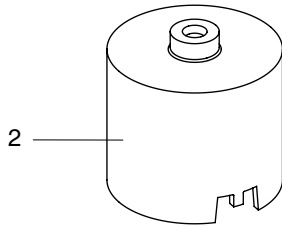
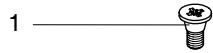

Ideal Standard

ALPHA

05.2023 / B665978

B C462 ..

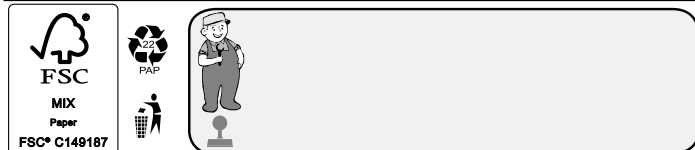
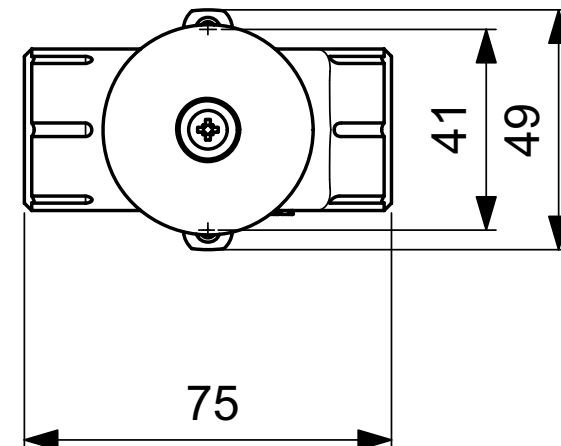
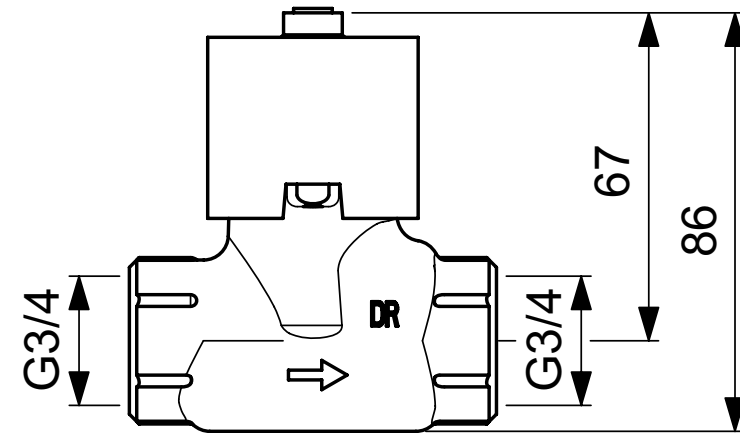

Ideal Standard International NV
Corporate Village – Gent Building
Da Vincilaan 2
1935 Zaventem
Belgium

<http://www.idealstandardinternational.com>

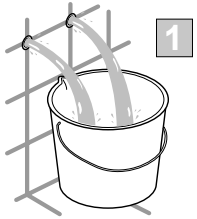

 P	bar	 MAX. 10	 5	 Q (3 bar)
 T	°C	 MAX. 80	 65 40	l/min
				118

