

Starck

ST 8941

Montageanleitung

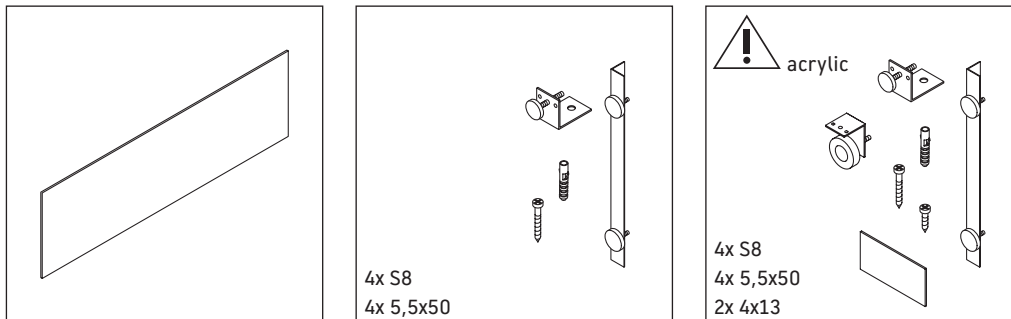

Starck # 7X0340



Alle weiteren Montageanleitungen beachten!

Verwendungshinweise

Technische Verbesserungen und optische Veränderungen an den abgebildeten Produkten behalten wir uns vor.

